

**Power Inductor** **SMDH2012B-SERIES**

**1. Features**

- 1. This specification applies Low Profile Power Inductors.
- 2. 100% Lead(Pb) & Halogen-Free and RoHS compliant.



**2. Dimension**

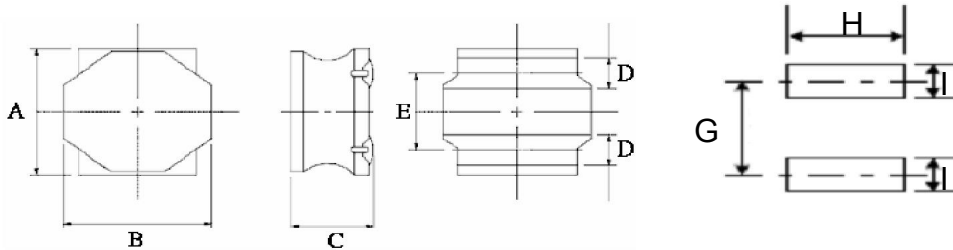

Series	A(mm)	B(mm)	C(mm)	D(mm)	E(mm)	G(mm)	H(mm)	I(mm)
SMDH2012B	2.0±0.1	2.0±0.1	1.2 max.	0.5±0.2	1.25±0.2	1.35 ref.	2.0 ref.	0.65 ref.

Units: mm

**3. Part Numbering**



- A: Series
- B: Dimension
- C: Control S/N
- D: Inductance                      2R2=2.2uH
- E: Inductance Tolerance        M=±20% ; Y=±30%

**4. Specification**

TOCOET Part Number	Inductance (uH)	Tolerance (%)	Test Frequency (Hz)	DCR (Ω) ±20%	I sat (A)	I rms (A)
SMDH2012B-1R0Y	1.0	±30%	1V100K	0.070	1.90	1.70
SMDH2012B-1R5Y	1.5	±30%	1V100K	0.090	1.65	1.50
SMDH2012B-2R2M	2.2	±20%	1V100K	0.107	1.35	1.37
SMDH2012B-3R3M	3.3	±20%	1V100K	0.190	1.00	1.02
SMDH2012B-4R7M	4.7	±20%	1V100K	0.241	0.90	0.91

Note:  
 Isat : Based on inductance change (ΔL/L0 : ≤-30%) @ ambient temp. 25°C  
 I rms : Based on temperature rise (ΔT : 40°C typ.)

SMDH2012B-SERIES

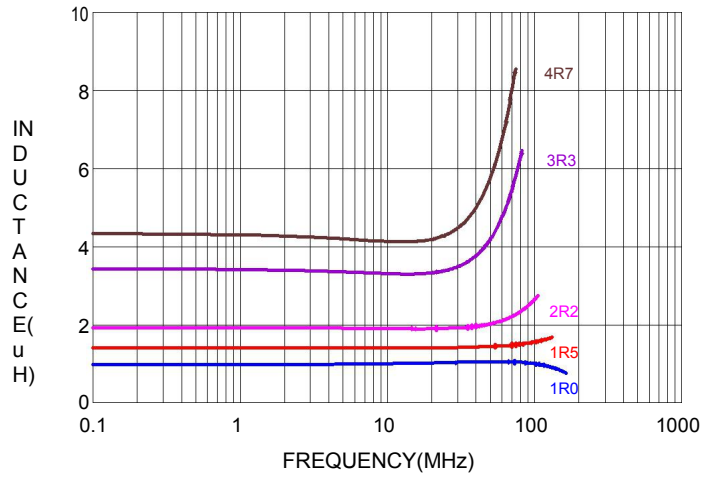

SMDH2012B-SERIES

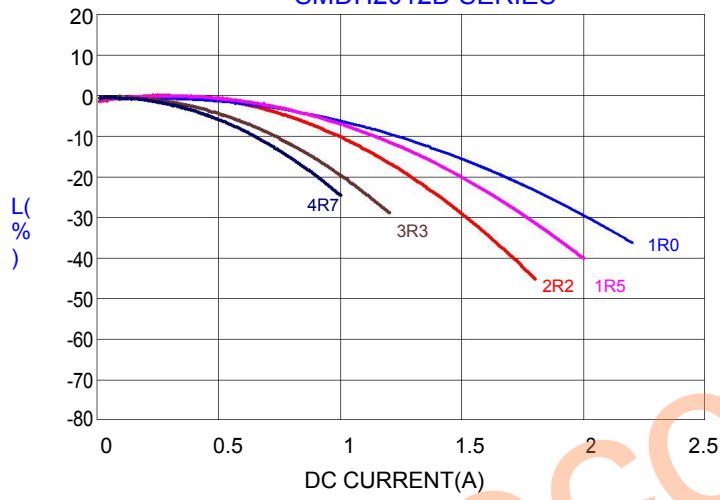

www.tocosc.com

<b>Power Inductor</b>	<b>SMDH201610CF-Series</b>
-----------------------	----------------------------

**1. Features**

1. This specification applies Low Profile Power Inductors.
2. 100% Lead(Pb) & Halogen-Free and RoHS compliant.

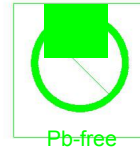

**2. Dimension**

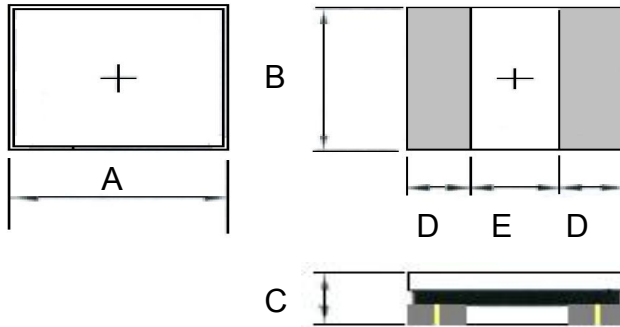

Series	A(mm)	B(mm)	C(mm)	D(mm)	E(mm)
SMDH201610CF	2.0 -0.1/+0.2	1.6 -0.1/+0.2	1.0max.	0.60 ref.	0.80 ref.

Units: mm

**3. Part Numbering**

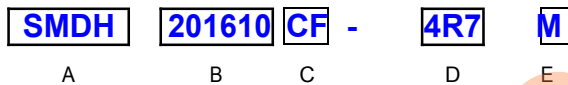

A: Series

B: Dimension

C: Lead Free

D: Inductance

E: Inductance Tolerance

Material

4R7=4.7uH

M=±20% ; Y=±30%

**4. Specification**

TOCOET Part Number	Inductance (uH)	Tolerance (%)	Test Frequency (Hz)	DCR (Ω) ±20%	I sat (A) typ.	I sat (A) Max.	I rms (A) typ.	I rms (A) Max.
SMDH201610CF-R47Y	0.47	±30%	0.1V/1M	0.044	3.00	2.70	2.60	2.35
SMDH201610CF-R68Y	0.68	±30%	0.1V/1M	0.062	2.45	2.00	2.25	2.05
SMDH201610CF-1R0Y	1.0	±30%	0.1V/1M	0.080	1.95	1.80	1.75	1.60
SMDH201610CF-1R5Y	1.5	±30%	0.1V/1M	0.130	1.65	1.46	1.40	1.26
SMDH201610CF-2R2M	2.2	±20%	0.1V/1M	0.145	1.45	1.26	1.35	1.20
SMDH201610CF-3R3M	3.3	±20%	0.1V/1M	0.245	1.05	0.90	1.05	0.95
SMDH201610CF-4R7M	4.7	±20%	0.1V/1M	0.360	0.85	0.77	1.00	0.90
SMDH201610CF-6R8M	6.8	±20%	0.1V/1M	0.500	0.80	0.72	0.70	0.55
SMDH201610CF-100M	10	±20%	0.1V/1M	0.720	0.62	0.55	0.50	0.45
SMDH201610CF-150M	15	±20%	0.1V/1M	1.400	0.50	0.45	0.40	0.36
SMDH201610CF-180M	18	±20%	0.1V/1M	1.800	0.45	0.40	0.38	0.34
SMDH201610CF-220M	22	±20%	0.1V/1M	2.000	0.43	0.38	0.30	0.27

Note:

I<sub>sat</sub> : Based on inductance change (ΔL/L0 : ≤30%) @ ambient temp. 25°C

I<sub>rms</sub> : Based on temperature rise (ΔT : 40°C.)

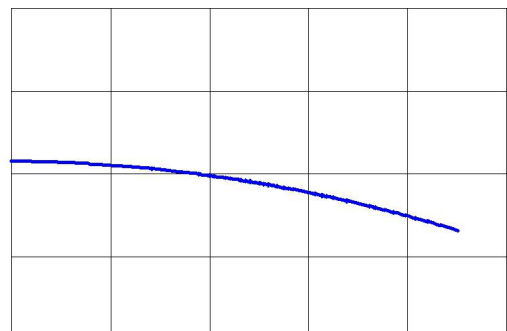
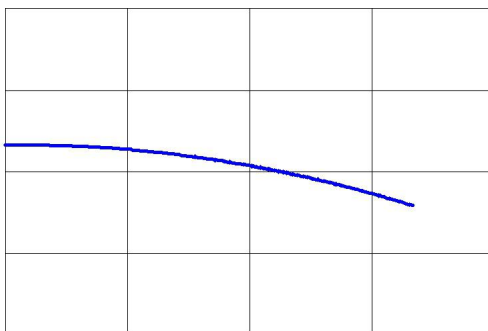
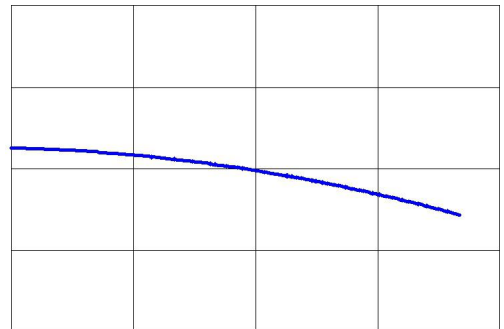
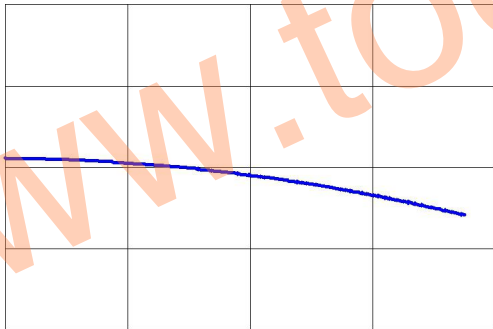
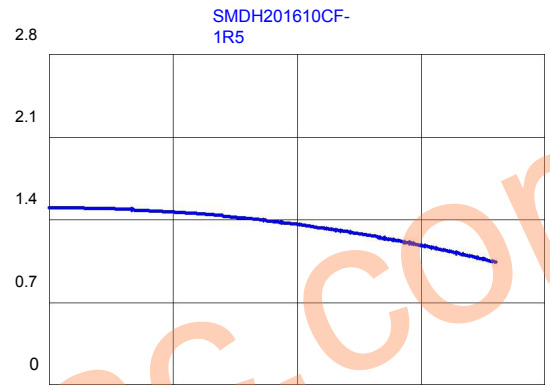
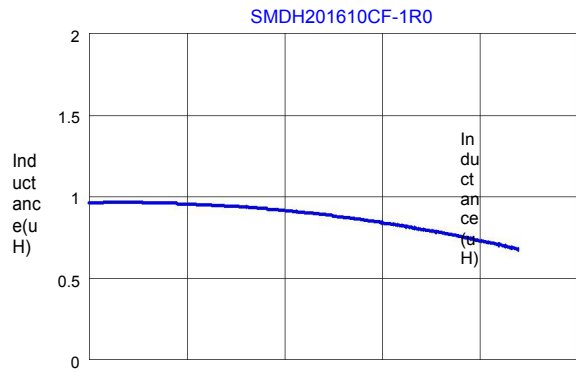
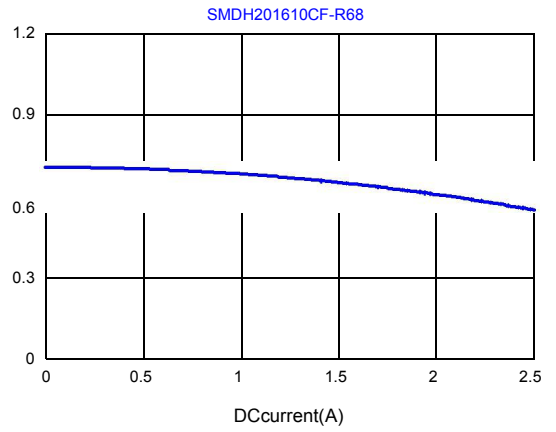
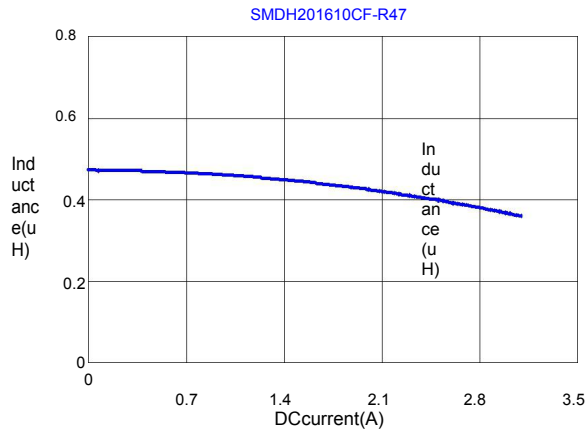

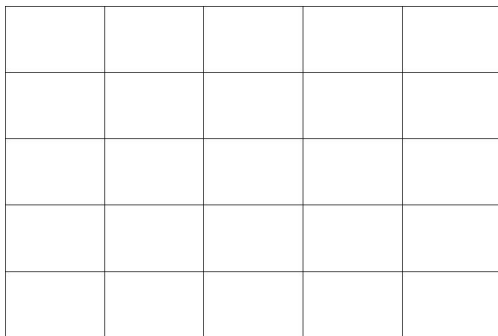
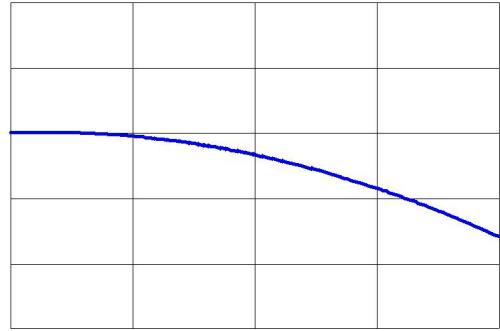
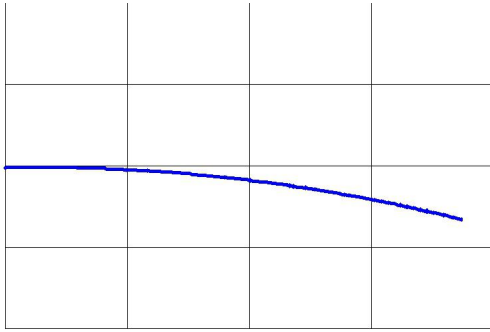

www.tocosc.com

# Power Inductor

SMDH2410B-Series

## 1. Features

1. This specification applies Low Profile Power Inductors.
2. 100% Lead(Pb) & Halogen-Free and RoHS compliant.

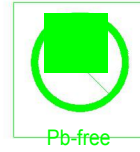

## 2. Dimension

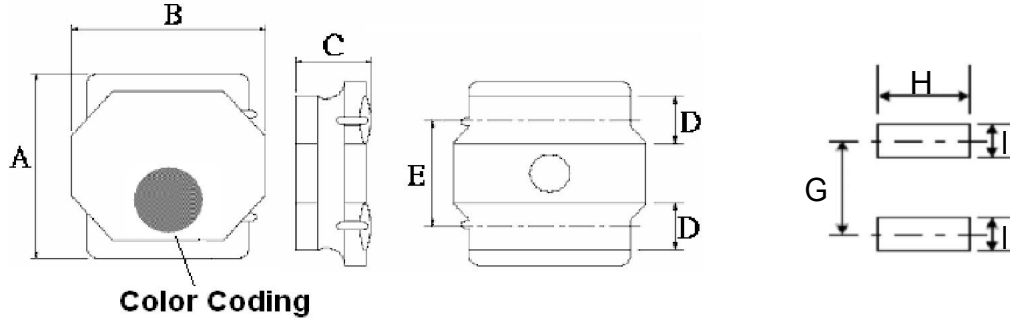

Series	A(mm)	B(mm)	C(mm)	D(mm)	E(mm)	G(mm)	H(mm)	I(mm)
SMDH2410A	2.4±0.1	2.4±0.1	1.0 max.	0.6±0.2	1.45±0.2	1.45 ref.	2.0 ref.	0.70 ref.

Units: mm

## 3. Part Numbering

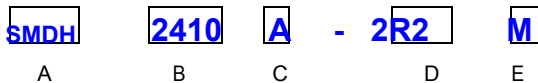

A: Series

B: Dimension

C: Control S/N

D: Inductance

E: Inductance Tolerance

2R2=2.2uH

M=±20% ; Y=±30%

## 4. Specification

TOCOET Part Number	Inductance (uH)	Tolerance (%)	Test Frequency (Hz)	SRF (MHz) min.	DCR (Ω) ±20%	I sat (A)	I rms (A)	Color Coding
SMDH2410A-R68Y	0.68	±30%	1V100K	120	0.060	2.20	1.57	Silver
SMDH2410A-1R0Y	1.0	±30%	1V100K	106	0.070	1.80	1.41	Silver
SMDH2410A-1R5M	1.5	±20%	1V100K	94	0.110	1.55	1.16	Silver
SMDH2410A-2R2M	2.2	±20%	1V100K	77	0.150	1.29	0.97	Silver
SMDH2410A-3R3M	3.3	±20%	1V100K	56	0.220	1.00	0.77	Silver
SMDH2410A-4R7M	4.7	±20%	1V100K	50	0.290	0.88	0.67	Silver
SMDH2410A-6R8M	6.8	±20%	1V100K	43	0.410	0.75	0.57	Silver
SMDH2410A-100M	10	±20%	1V100K	32	0.690	0.55	0.45	Silver
SMDH2410A-150M	15	±20%	1V100K	27	1.020	0.47	0.37	Silver
SMDH2410A-220M	22	±20%	1V100K	22	1.470	0.39	0.30	Silver

Note:

I<sub>sat</sub> : Based on inductance change (ΔL/L0 : ≤-30%) @ ambient temp. 25°C

I<sub>rms</sub> : Based on temperature rise (ΔT : 40°C typ.)

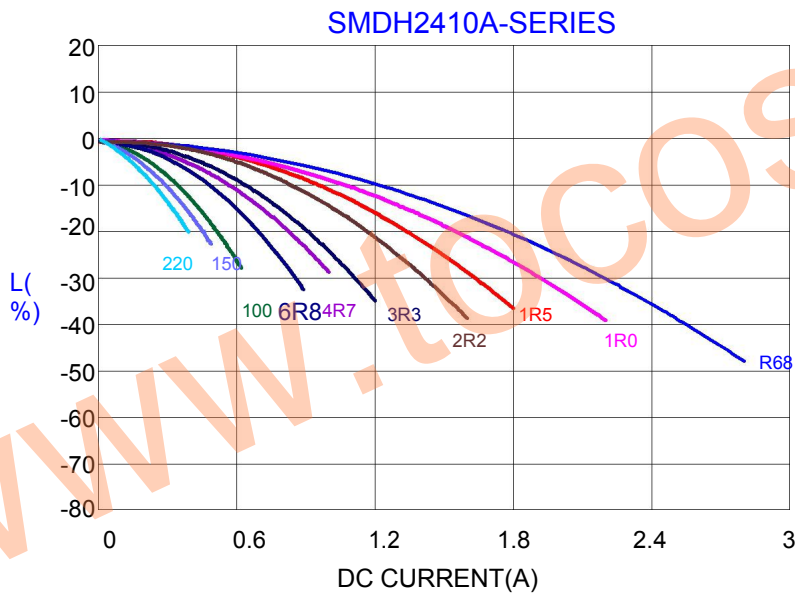
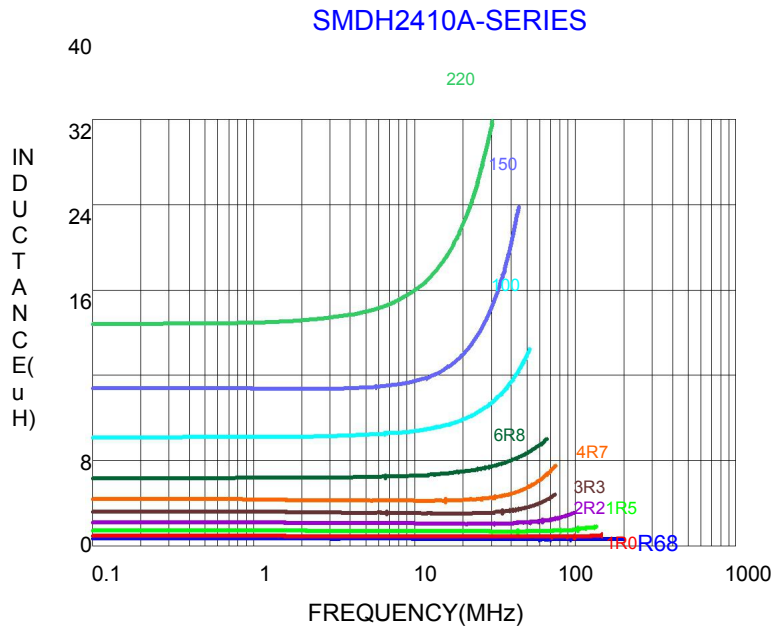

# Power Inductor

**SMDH2412A-  
Series**

## 1. Features

1. This specification applies Low Profile Power Inductors.
2. 100% Lead(Pb) & Halogen-Free and RoHS compliant.



## 2. Dimension

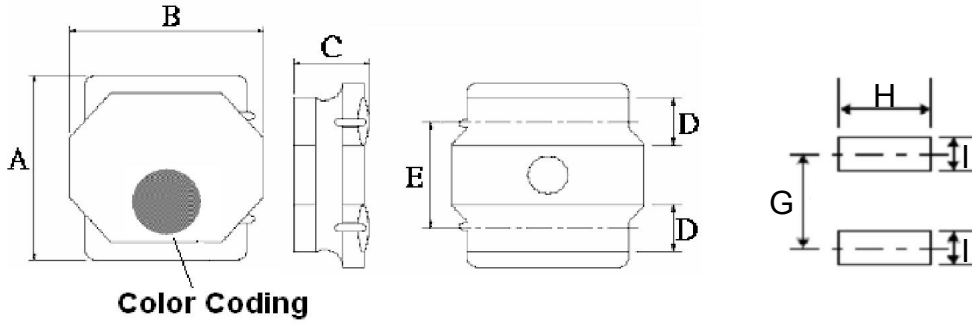

Series	A(mm)	B(mm)	C(mm)	D(mm)	E(mm)	G(mm)	H(mm)	I(mm)
SMDH2412A	2.4±0.1	2.4±0.1	1.2 max.	0.6±0.2	1.45±0.2	1.45 ref.	2.0 ref.	0.70 ref.

## 3. Part Numbering

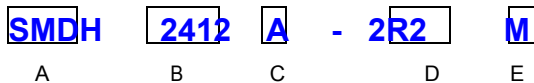

- A: Series
- B: Dimension
- C: Control S/N
- D: Inductance  
2R2=2.2uH
- E: Inductance Tolerance  
M=±20% ; Y=±30%

## 4. Specification

TOCOET Part Number	Inductance (uH)	Tolerance (%)	Test Frequency (Hz)	SRF (MHz) min.	DCR (Ω) ±20%	I sat (A)	I rms (A)	Color Coding
SMDH2412A-1R0Y	1.0	±30%	1V100K	101	0.077	2.35	1.30	Silver
SMDH2412A-1R5Y	1.5	±30%	1V100K	89	0.100	2.10	1.15	Silver
SMDH2412A-2R2M	2.2	±20%	1V100K	72	0.140	1.70	1.00	Silver
SMDH2412A-3R3M	3.3	±20%	1V100K	56	0.225	1.40	0.75	Silver
SMDH2412A-4R7M	4.7	±20%	1V100K	45	0.300	1.15	0.65	Silver
SMDH2412A-6R8M	6.8	±20%	1V100K	34	0.420	0.95	0.55	Silver
SMDH2412A-100M	10	±20%	1V100K	29	0.600	0.81	0.45	Silver

Note:

I<sub>sat</sub> : Based on inductance change (ΔL/L0 : ≤-30%) @ ambient temp. 25°C

I<sub>rms</sub> : Based on temperature rise (ΔT : 40°C typ.)



SMDH2412A-SERIES

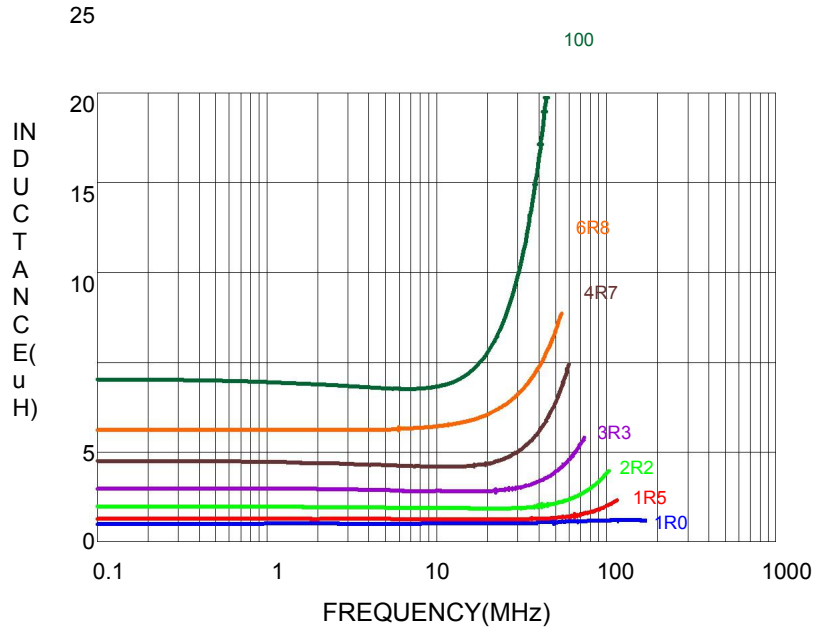

SMDH2412A-ERIES

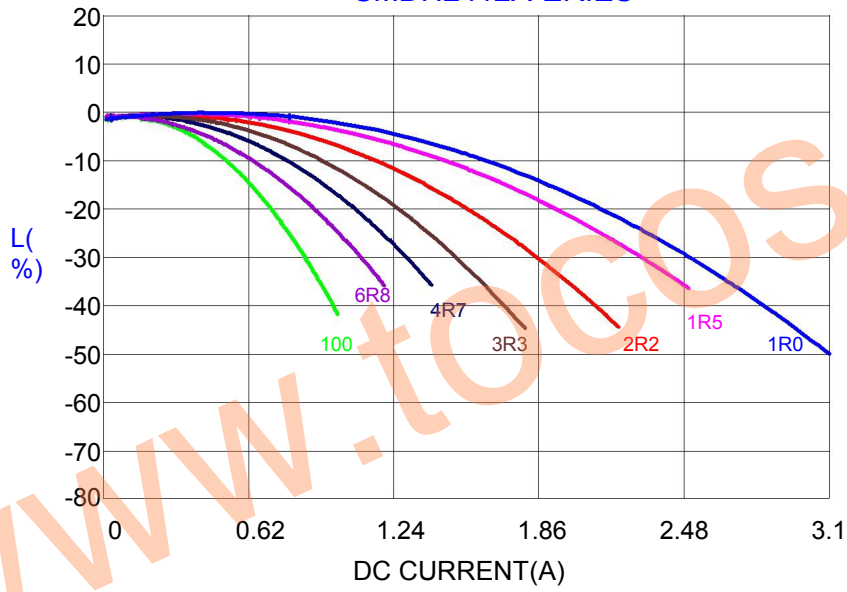

**Power Inductor** **SMDH252008MF-SERIES**

**1. Features**

- 1. This specification applies Low Profile Power Inductors.
- 2. 100% Lead(Pb) & Halogen-Free and RoHS compliant.

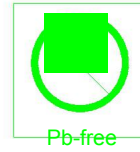

**2. Dimension**

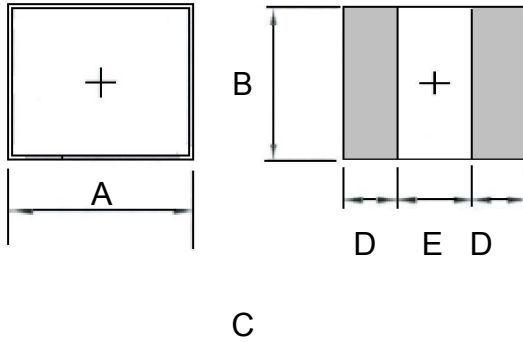

Series	A(mm)	B(mm)	C(mm)	D(mm)	E(mm)
SMDH252008MF	2.50-0.1/+0.3	2.0-0.05/+0.35	0.80 max.	0.85 ref.	0.80 ref.

Units: mm

**3. Part Numbering**

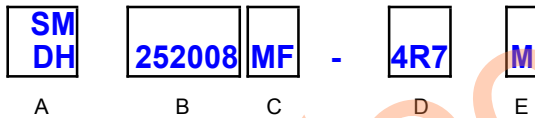

- A: Series
- B: Dimension
- C: Lead Free
- D: Inductance  
4R7=4.7uH
- E: Inductance Tolerance  
M=±20%

**4. Specification**

TOCOET Part Number	Inductance (uH)	Tolerance (%)	Test Frequency (Hz)	DCR (Ω) typ.	DCR (Ω) Max.	I sat (A) typ.	I sat (A) Max.	I rms (A) typ	I rms (A) Max.
SMDH252008MF-R47M	0.47	±20%	0.1V/1M	0.080	0.096	2.50	2.20	1.45	1.25
SMDH252008MF-R68M	0.68	±20%	0.1V/1M	0.100	0.120	2.05	1.80	1.35	1.15
SMDH252008MF-1R0M	1.0	±20%	0.1V/1M	0.120	0.145	1.75	1.50	1.20	1.05
SMDH252008MF-1R5M	1.5	±20%	0.1V/1M	0.170	0.200	1.65	1.45	1.05	0.95
SMDH252008MF-2R2M	2.2	±20%	0.1V/1M	0.210	0.250	1.40	1.20	0.95	0.85
SMDH252008MF-3R3M	3.3	±20%	0.1V/1M	0.300	0.360	1.10	0.95	0.85	0.75
SMDH252008MF-4R7M	4.7	±20%	0.1V/1M	0.400	0.480	0.90	0.80	0.70	0.63
SMDH252008MF-6R8M	6.8	±20%	0.1V/1M	0.670	0.800	0.75	0.65	0.55	0.50
SMDH252008MF-100M	10.0	±20%	0.1V/1M	0.930	1.110	0.55	0.50	0.45	0.41

Note:

Isat : Based on inductance change (ΔL/L0 : ≤30%) @ ambient temp. 25°C

Irms : Based on temperature rise (ΔT : 40°C.) Max

**TOCOET**

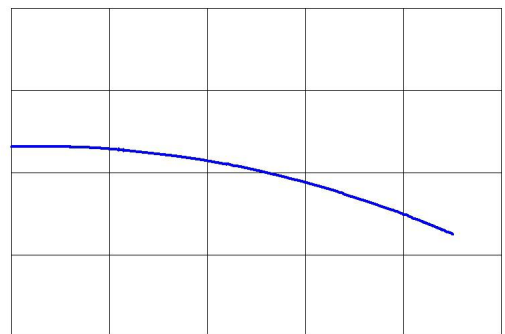
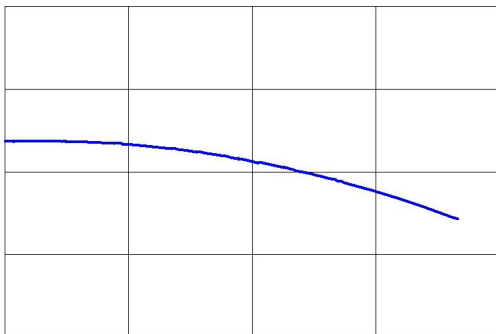
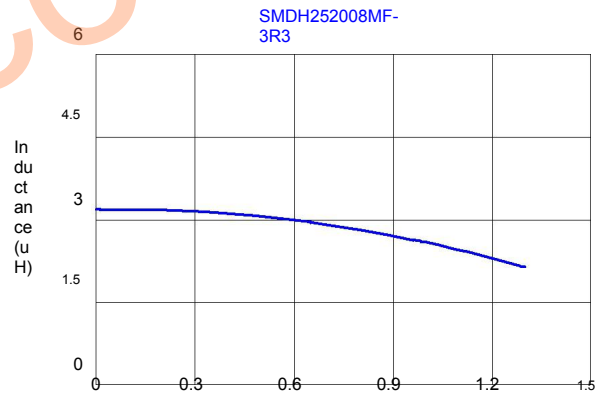
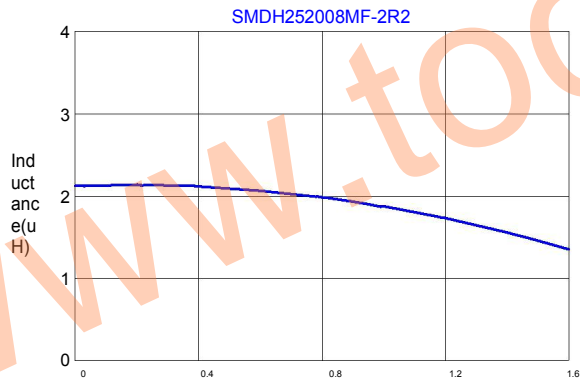
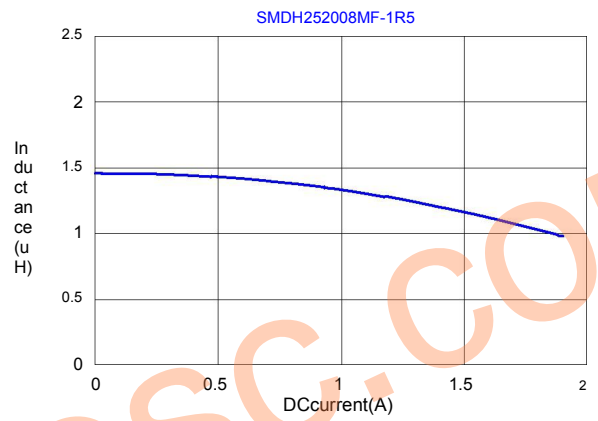
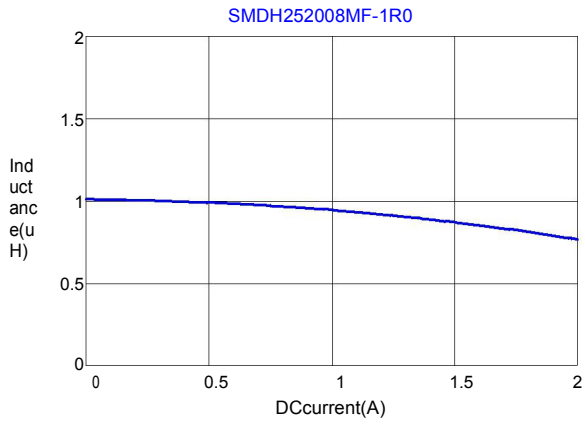
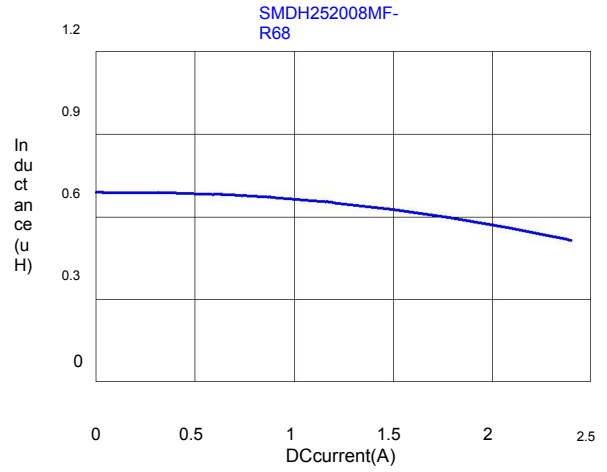
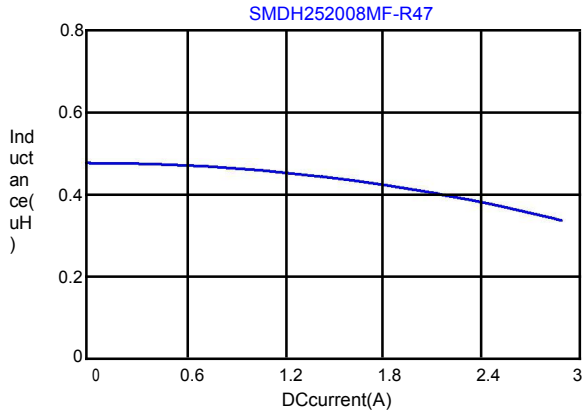

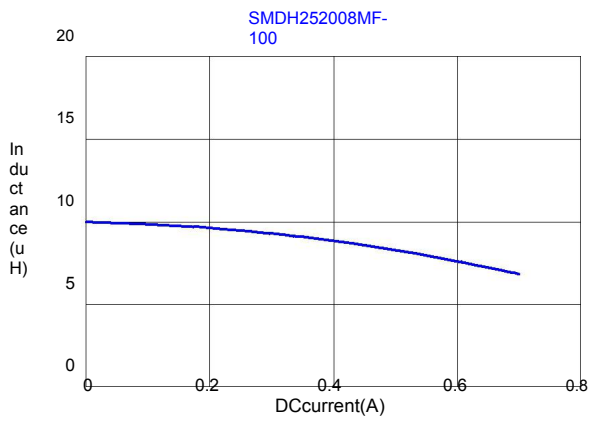

www.tocosc.com

**Power Inductor** **SMDH252012CF-SERIES**

**1. Features**

- 1. This specification applies Low Profile Power Inductors.
- 2. 100% Lead(Pb) & Halogen-Free and RoHS compliant.

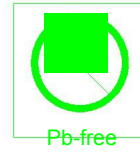

**2. Dimension**

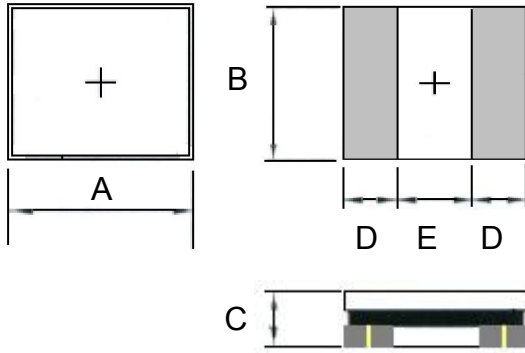

Series	A(mm)	B(mm)	C(mm)	D(mm)	E(mm)
SMDH252012CF	2.5±0.2	2.0±0.2	1.2Max	0.85 ref.	0.80 ref.

Units: mm

**3. Part Numbering**

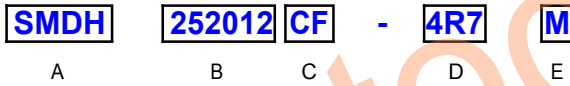

- A: Series
- B: Dimension
- C: Lead Free
- D: Inductance
- E: Inductance Tolerance
- Material: 4R7=4.7uH
- M=±20% : Y=±30%

**4. Specification**

TOCOET Part Number	Inductance (uH)	Tolerance (%)	Test Frequency (Hz)	DCR (Ω) ±20%	I sat (A) typ.	I sat (A) Max.	I rms (A) typ	I rms (A) Max.
SMDH252012CF-1R0Y	1.0	±30%	0.1V/1M	0.073	2.80	2.24	2.20	1.76
SMDH252012CF-1R5Y	1.5	±30%	0.1V/1M	0.100	2.20	1.76	1.86	1.48
SMDH252012CF-2R2M	2.2	±20%	0.1V/1M	0.129	1.80	1.44	1.70	1.36
SMDH252012CF-3R3M	3.3	±20%	0.1V/1M	0.220	1.30	1.04	1.20	0.96
SMDH252012CF-4R7M	4.7	±20%	0.1V/1M	0.290	1.10	0.88	1.04	0.83
SMDH252012CF-6R8M	6.8	±20%	0.1V/1M	0.370	0.94	0.75	0.94	0.75
SMDH252012CF-100M	10	±20%	0.1V/1M	0.570	0.82	0.65	0.84	0.60
SMDH252012CF-150M	15	±20%	0.1V/1M	0.835	0.70	0.60	0.50	0.45
SMDH252012CF-220M	22	±20%	0.1V/1M	1.200	0.60	0.55	0.45	0.40

Note:

- I<sub>sat</sub> : Based on inductance change (ΔL/L0 : ≤30%) @ ambient temp. 25°C
- I<sub>rms</sub> : Based on temperature rise (ΔT : 40°C.Max)

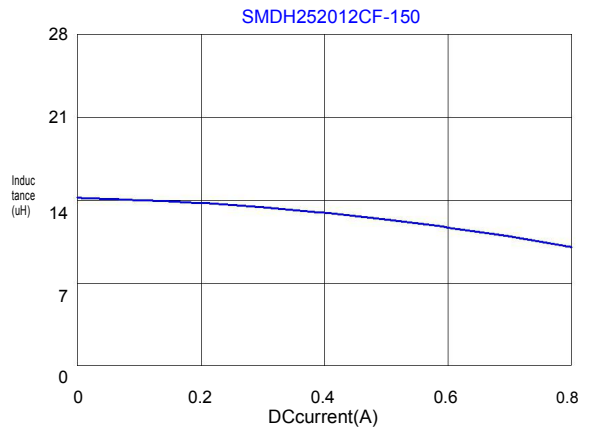
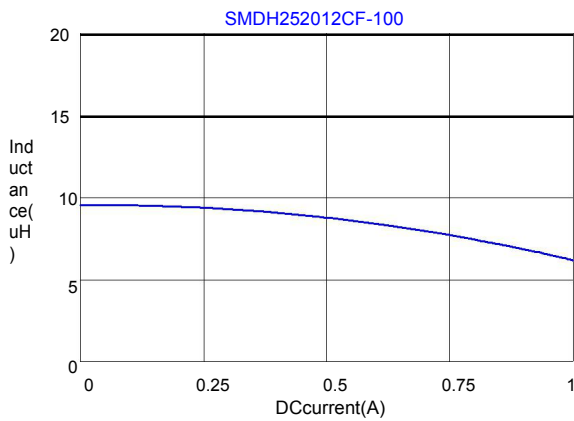
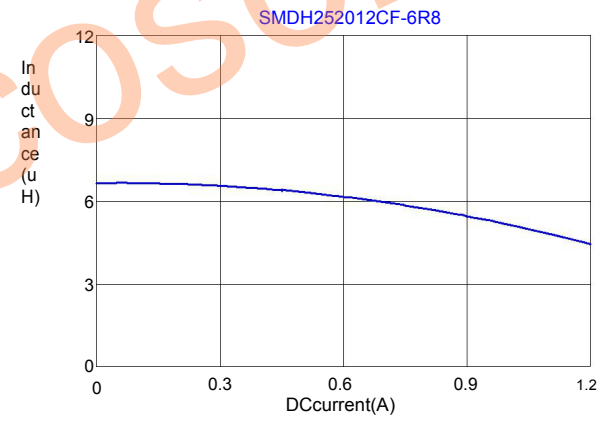
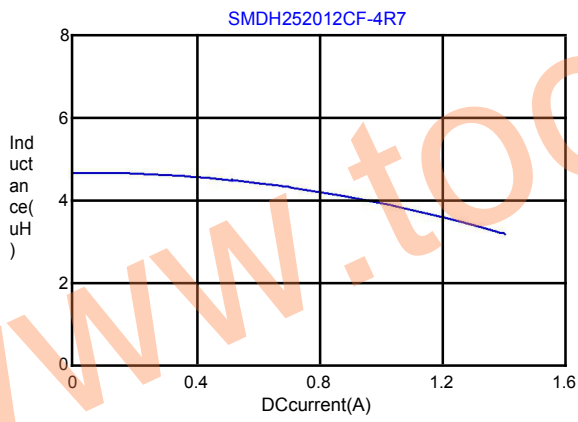
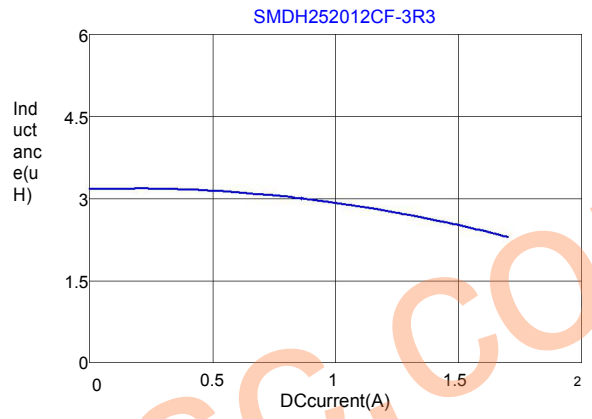
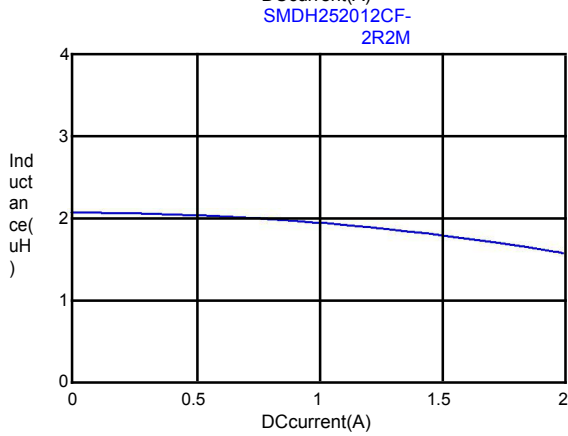
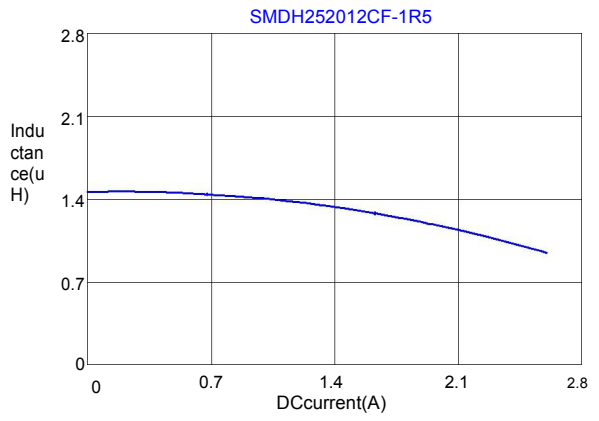
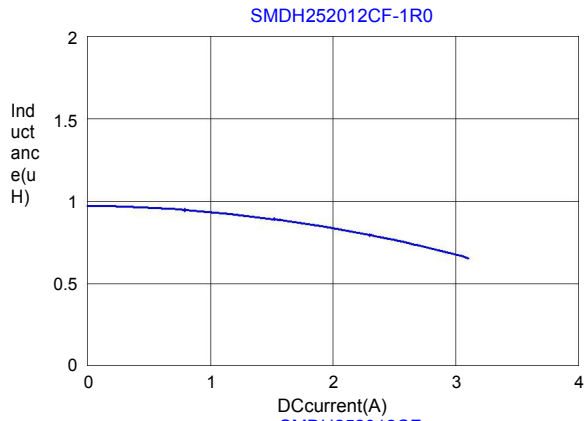

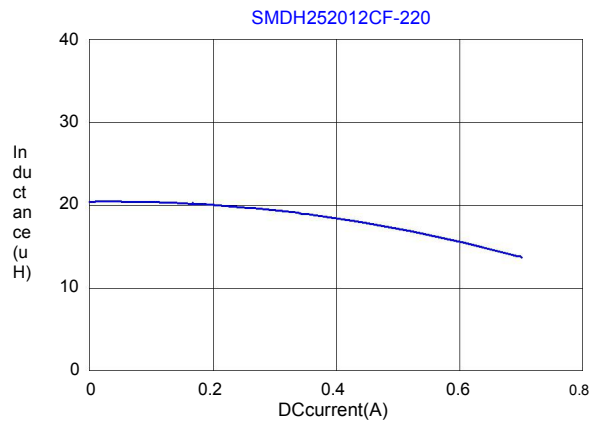

www.tocosc.com

**Power Inductor** **SMDH3010TF-SERIES**

**1. Features**

- 1. This specification applies Low Profile Power Inductors.
- 2. 100% Lead(Pb) & Halogen-Free and RoHS compliant.

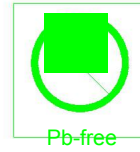

**2. Dimension**

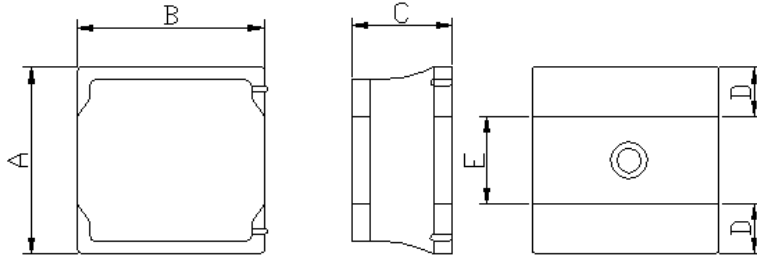

Series	A(mm)	B(mm)	C(mm)	D(mm)	E(mm)
SMDH3010TF	3.0±0.2	3.0±0.2	1.0max.	1.0 ref.	1.0 ref.

Units: mm

**3. Part Numbering**

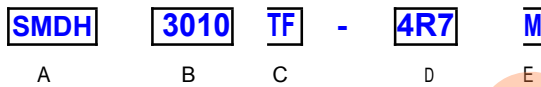

- A: Series
- B: Dimension
- C: Lead Free
- D: Inductance  
4R7=4.7uH
- E: Inductance Tolerance  
M=±20% ; Y=±30%

**4. Specification**

TOCOET Part Number	Inductance (uH)	Tolerance (%)	Test Frequency (Hz)	DCR (Ω) ±20%	I sat (A) typ.	I sat (A) max.	I rms (A) typ.	I rms (A) max.
SMDH3010TF-1R0Y	1.0	±30%	0.1V/1M	0.055	2.20	1.80	2.50	2.10
SMDH3010TF-1R5Y	1.5	±30%	0.1V/1M	0.070	2.00	1.50	2.20	1.90
SMDH3010T - 2R2M	2.2	±20%	0.1V/1M	0.090	1.60	1.30	2.10	1.70
SMDH3010TF-3R3M	3.3	±20%	0.1V/1M	0.130	1.30	1.10	1.70	1.50
SMDH3010TF-4R7M	4.7	±20%	0.1V/1M	0.170	1.20	0.90	1.50	1.30
SMDH3010TF-6R8M	6.8	±20%	0.1V/1M	0.260	0.90	0.77	1.30	1.00
SMDH3010TF-100M	10	±20%	0.1V/1M	0.350	0.75	0.63	1.00	0.80
SMDH3010TF-150M	15	±20%	0.1V/1M	0.510	0.65	0.54	0.80	0.70
SMDH3010TF-220M	22	±20%	0.1V/1M	0.750	0.55	0.43	0.75	0.60

Note:

I sat : Based on inductance change (ΔL/L0 : ≤30%) @ ambient temp. 25°C

I rms : Based on temperature rise (ΔT : 40°C.) Max



SMDH3010TF-1R0

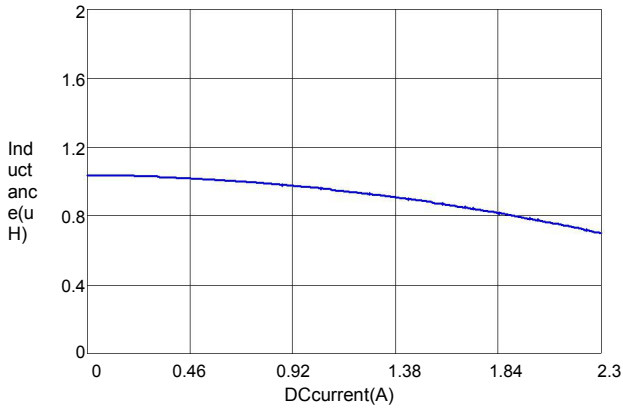

SMDH3010TF-1R5

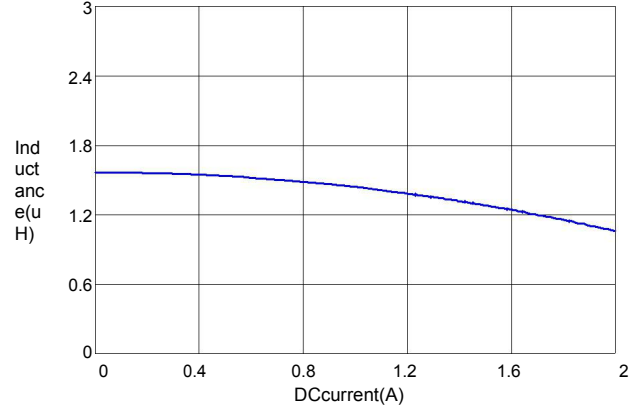

SMDH3010TF-2R2

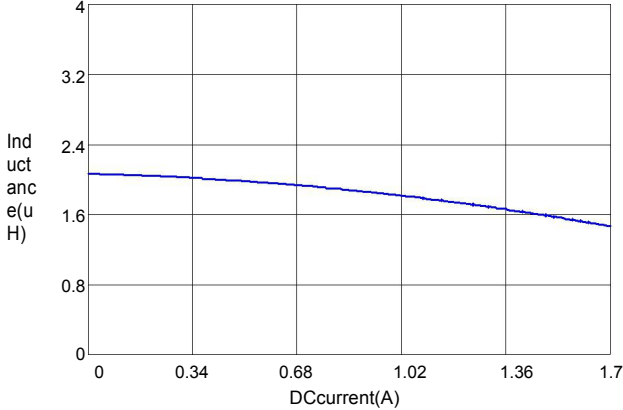

SMDH3010TF-3R3

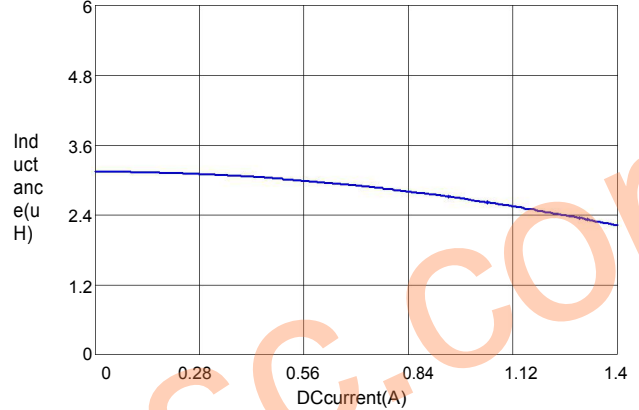

SMDH3010TF-4R7

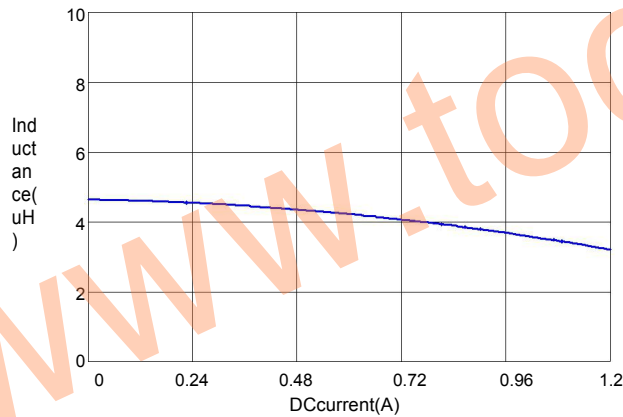

SMDH3010TF-6R8

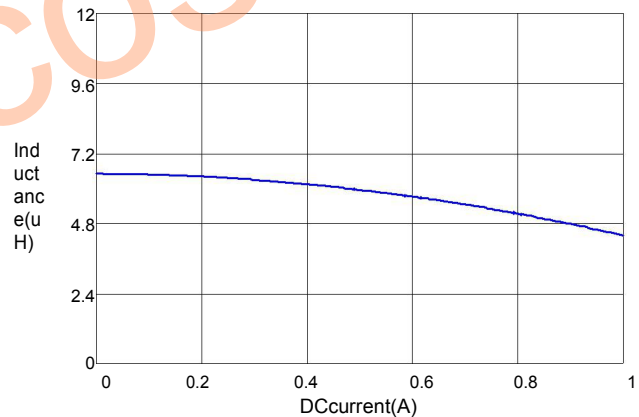

SMDH3010TF-100

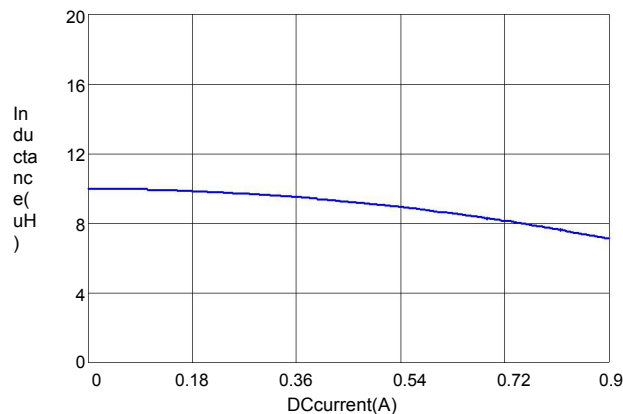

SMDH3010TF-150

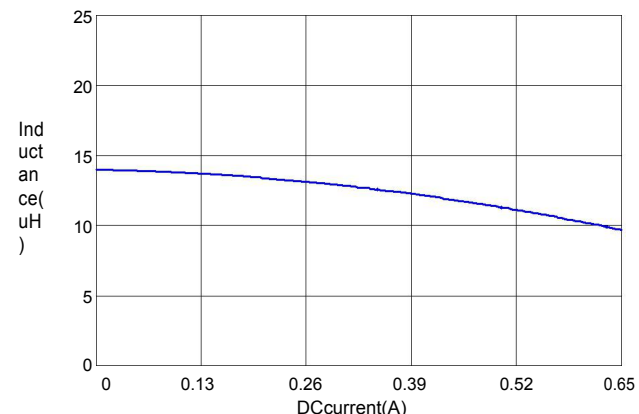

SMDH3010TF-220

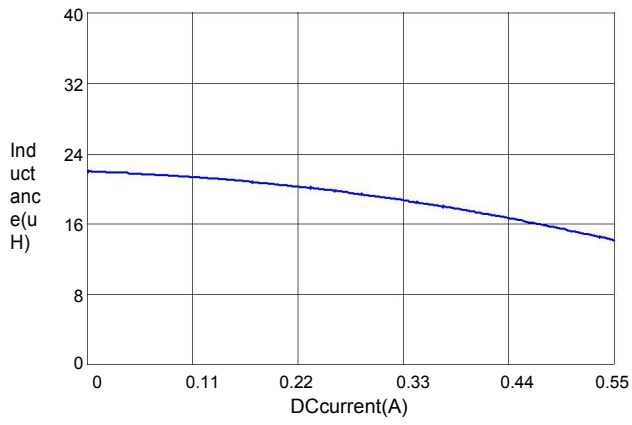

www.tocosc.com

**Power Inductor** **SMDH3012TF-SERIES**

**1. Features**

- 1. This specification applies Low Profile Power Inductors.
- 2. 100% Lead(Pb) & Halogen-Free and RoHS compliant.

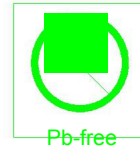

**2. Dimension**

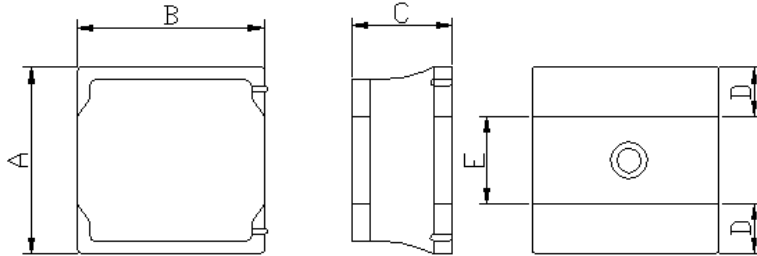

Series	A(mm)	B(mm)	C(mm)	D(mm)	E(mm)
SMDH3012TF	3.0±0.2	3.0±0.2	1.2 max.	1.0 ref.	1.0 ref.

Units: mm

**3. Part Numbering**

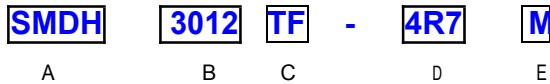

- A: Series
- B: Dimension
- C: Lead Free
- D: Inductance 4R7=4.7uH
- E: Inductance Tolerance M=±20% ; Y=±30%

**4. Specification**

TOCOET Part Number	Inductance (uH)	Tolerance (%)	Test Frequency (Hz)	DCR (Ω) ±20%	I sat (A) typ.	I sat (A) max.	I rms (A) typ	I rms (A) max.
SMDH3012TF-1R0Y	1.0	±30%	0.1V/1M	0.042	2.50	2.15	2.20	2.00
SMDH3012TF-1R5Y	1.5	±30%	0.1V/1M	0.056	2.00	1.70	2.00	1.85
SMDH3012TF-2R2M	2.2	±20%	0.1V/1M	0.080	1.80	1.50	1.90	1.70
SMDH3012TF-3R3M	3.3	±20%	0.1V/1M	0.100	1.50	1.20	1.70	1.55
SMDH3012TF-4R7M	4.7	±20%	0.1V/1M	0.130	1.30	1.05	1.50	1.30
SMDH3012TF-6R8M	6.8	±20%	0.1V/1M	0.180	1.20	0.90	1.20	1.05
SMDH3012TF-100M	10	±20%	0.1V/1M	0.245	0.90	0.76	1.00	0.89
SMDH3012TF-150M	15	±20%	0.1V/1M	0.386	0.80	0.62	0.90	0.74
SMDH3012TF-220M	22	±20%	0.1V/1M	0.580	0.60	0.49	0.70	0.61

Note:

I<sub>sat</sub> : Based on inductance change (ΔL/L0 : ≤30%) @ ambient temp. 25°C

I<sub>rms</sub> : Based on temperature rise (ΔT : 40°C.) Max

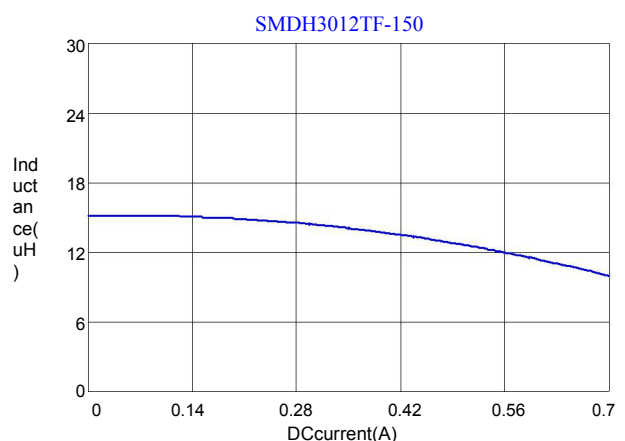
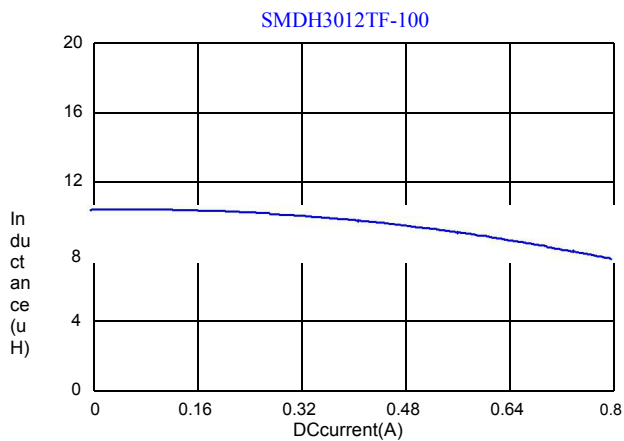
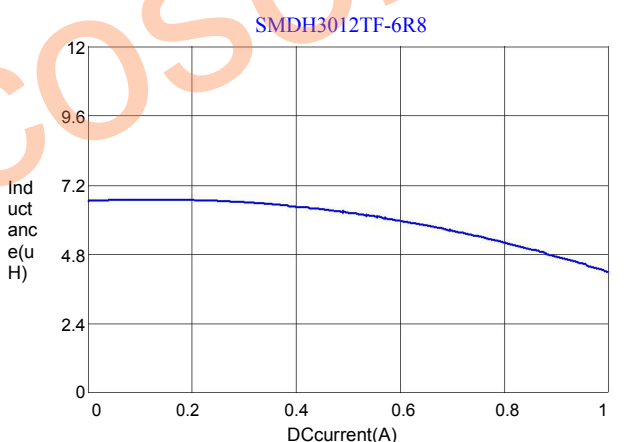
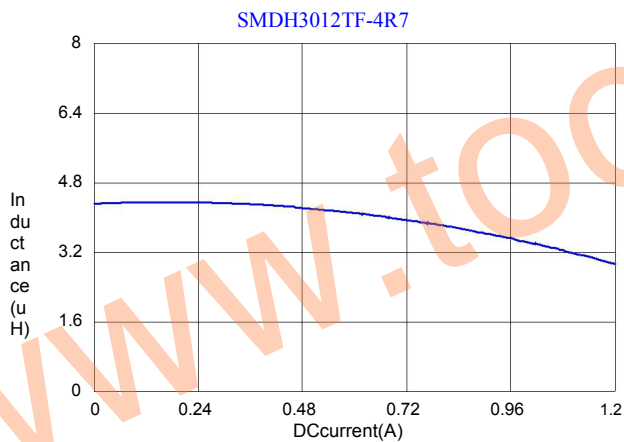
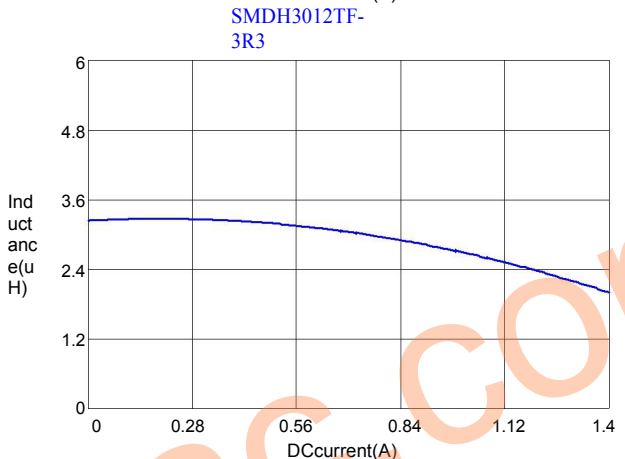
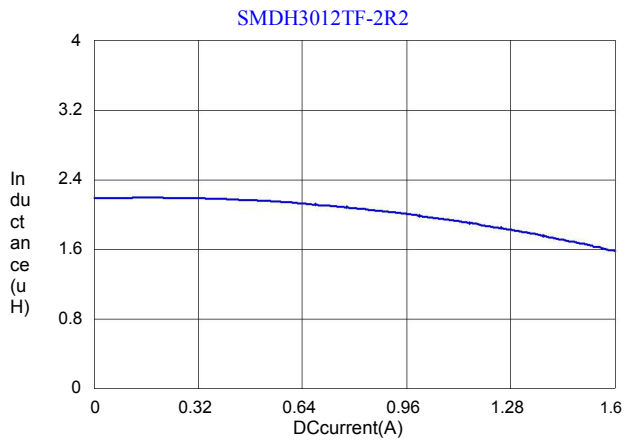
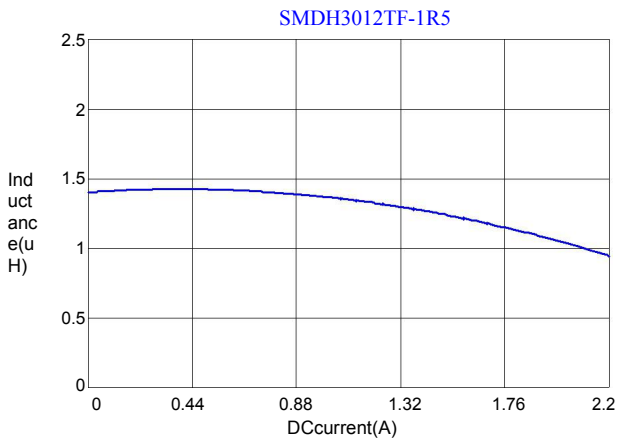
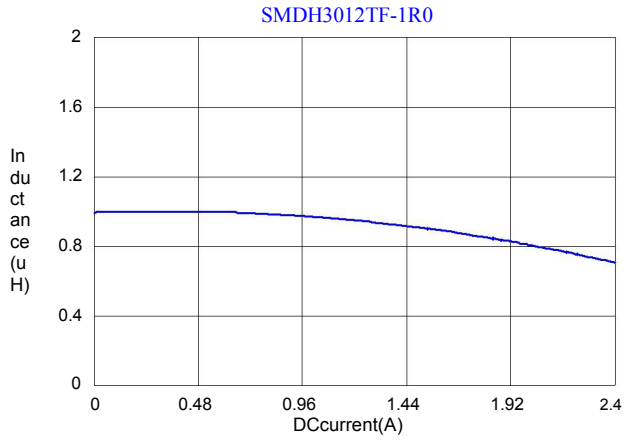

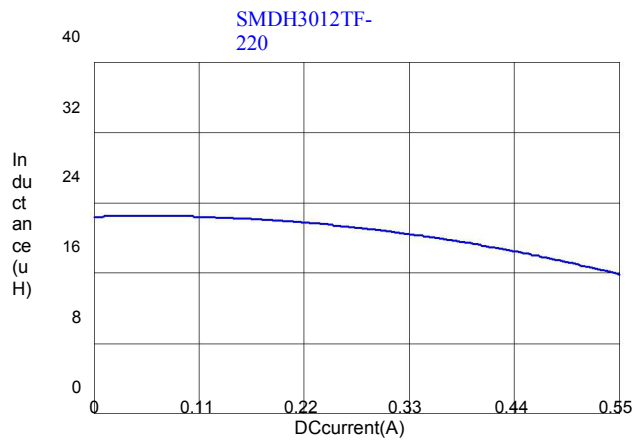

www.tocosc.com

**Power Inductor** **SMDH3015TF-SERIES**

**1. Features**

- 1. This specification applies Low Profile Power Inductors.
- 2. 100% Lead(Pb) & Halogen-Free and RoHS compliant.



**2. Dimension**

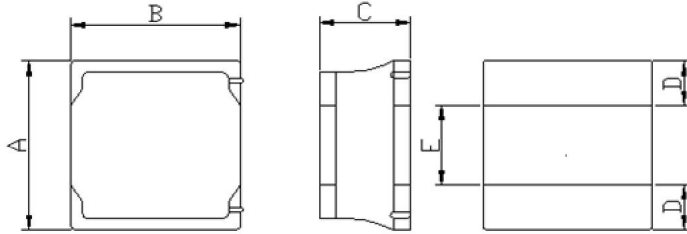

Series	A(mm)	B(mm)	C(mm)	D(mm)	E(mm)
SMDH3015TF	3.0±0.2	3.0±0.2	1.5 max.	1.0 ref.	1.0 ref.

Units: mm

**3. Part Numbering**

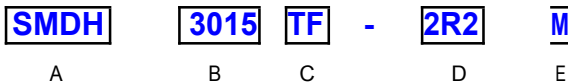

- A: Series
- B: Dimension
- C: Lead Free
- D: Inductance
- E: Inductance Tolerance

2R2=2.2uH  
M=±20%; Y=±30%

**4. Specification**

TOCOET Part Number	Inductance (uH)	Tolerance (%)	Test Frequency (Hz)	DCR (Ω) ±20%	I sat (A)typ	I sat (A)max.	I rms (A)typ	I rms (A)max.	SRF (MHz) typ.
SMDH3015TF-1R0Y	1.0	±30%	1V100K	0.030	2.20	2.00	2.20	2.00	100
SMDH3015TF-1R5Y	1.5	±30%	1V100K	0.040	2.00	1.80	2.00	1.80	87
SMDH3015TF-2R2M	2.2	±20%	1V100K	0.060	1.70	1.50	1.70	1.50	64
SMDH3015TF-3R3M	3.3	±20%	1V100K	0.080	1.40	1.20	1.40	1.20	49
SMDH3015TF-4R7M	4.7	±20%	1V100K	0.120	1.20	1.00	1.20	1.00	40
SMDH3015TF-6R8M	6.8	±20%	1V100K	0.160	1.00	0.90	1.00	0.90	36
SMDH3015TF-100M	10	±20%	1V100K	0.220	0.75	0.65	0.80	0.70	28
SMDH3015TF-150M	15	±20%	1V100K	0.320	0.65	0.55	0.70	0.60	23
SMDH3015TF-220M	22	±20%	1V100K	0.460	0.55	0.45	0.60	0.50	20
SMDH3015TF-330M	33	±20%	1V100K	0.800	0.40	0.35	0.45	0.40	18
SMDH3015TF-470M	47	±20%	1V100K	1.200	0.35	0.30	0.40	0.35	17

Note:

I<sub>sat</sub> : Based on inductance change (ΔL/L0 : ≤30%) @ ambient temp. 25°C

I<sub>rms</sub> : Based on temperature rise (ΔT : 40°C ) MAX

# TOCOET

SMDH3015TF-1R0

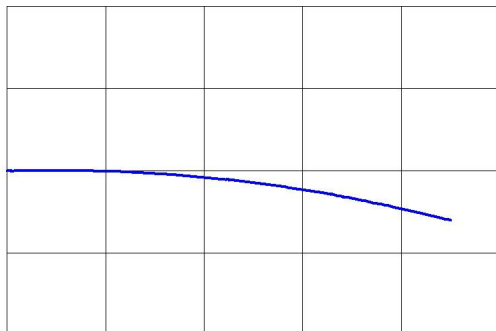
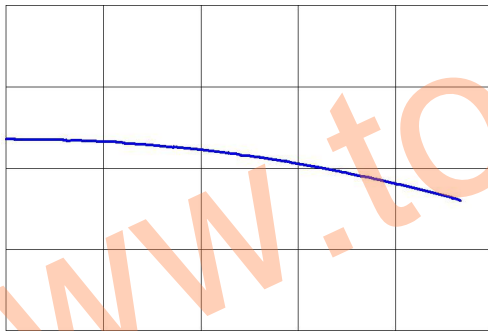
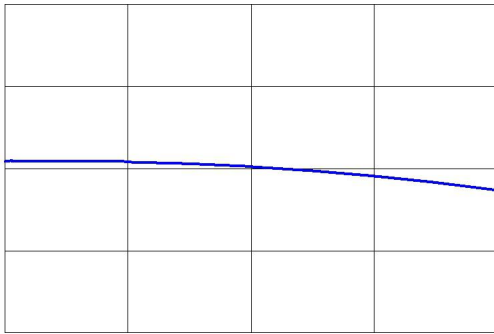
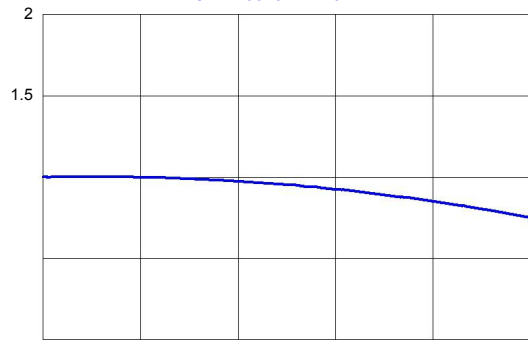

SMDH3015TF-1R5

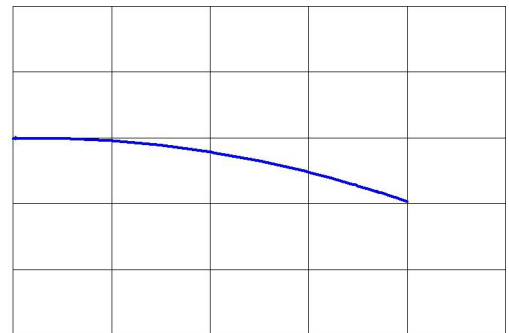
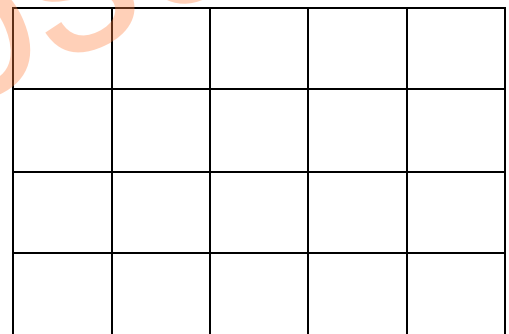
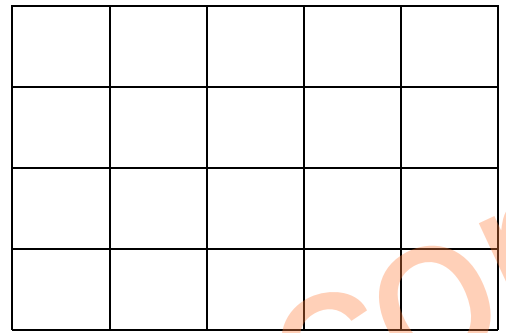
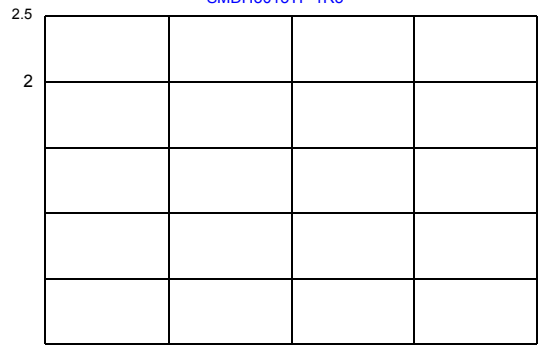

www.tocosc.com

# TOCOET

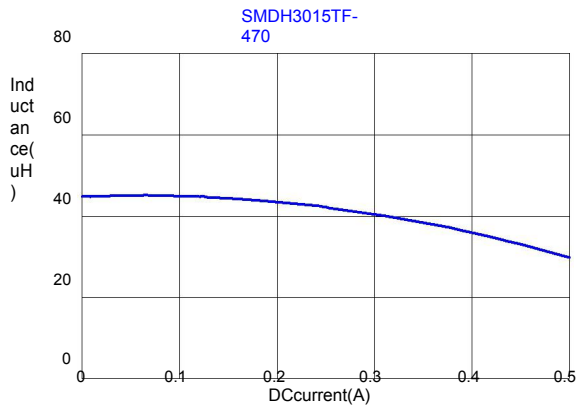
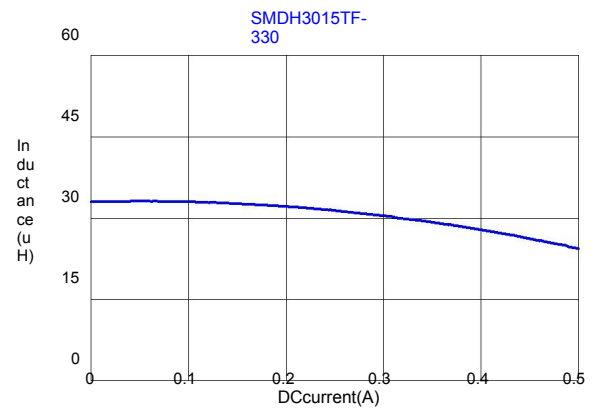
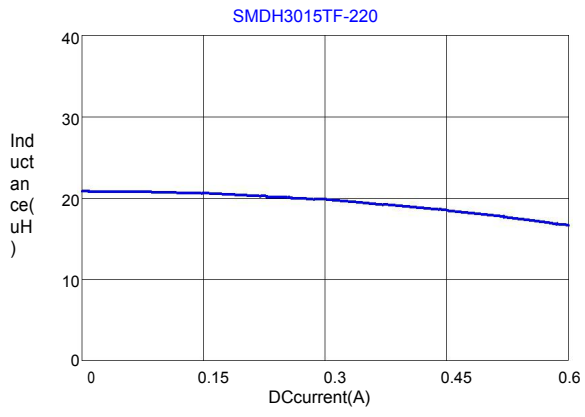

www.tocosc.com



# Power Inductor

**SMDH4010TF-SERIES**

## 1. Features

1. This specification applies Low Profile Power Inductors.
2. 100% Lead(Pb) & Halogen-Free and RoHS compliant.



## 2. Dimension

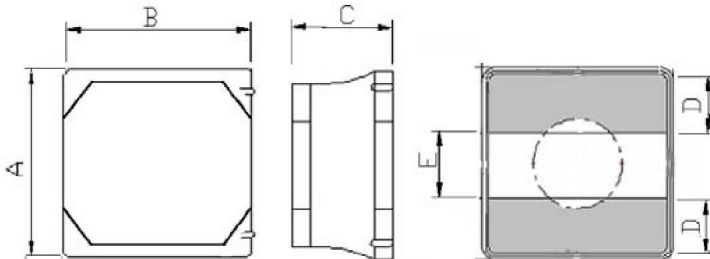

Series	A(mm)	B(mm)	C(mm)	D(mm)	E(mm)
SMDH4010TF	4.0±0.2	4.0±0.2	1.0 max.	1.2 ref.	1.6 ref.

Units: mm

## 3. Part Numbering

**SMDH**   **4010**   **TF**   -   **100**   **M**

A                      B                      C                      D                      E

- A: Series
- B: Dimension
- C: Lead Free
- D: Inductance                      100=10uH
- E: Inductance Tolerance                      M=±20% ; Y=±30%

## 4. Specification

TOCOET Part Number	Inductance (uH)	Tolerance (%)	Test Frequency (Hz)	SRF (MHz) typ.	DCR (Ω) ±20%	I sat (A)typ.	I sat (A)Max.	I rms (A)typ.	I rms (A)Max.
SMDH4010TF -1R0Y	1.0	±30%	1V100K	116	0.056	2.40	2.00	2.30	1.90
SMDH4010TF -2R2M	2.2	±20%	1V100K	73	0.085	1.50	1.20	1.80	1.50
SMDH4010TF-3R3M	3.3	±20%	1V100K	58	0.100	1.30	1.10	1.70	1.40
SMDH4010TF-4R7M	4.7	±20%	1V100K	47	0.140	1.20	0.95	1.50	1.20
SMDH4010TF-6R8M	6.8	±20%	1V100K	38	0.200	1.00	0.80	1.20	1.00
SMDH4010TF-100M	10	±20%	1V100K	31	0.300	0.80	0.62	0.90	0.75
SMDH4010TF-150M	15	±20%	1V100K	24	0.430	0.70	0.54	0.80	0.60
SMDH4010TF-220M	22	±20%	1V100K	19	0.570	0.60	0.45	0.80	0.50

Note:

- Isat : Based on inductance change (ΔL/L0 : ≤30%) @ ambient temp. 25°C
- Irms : Based on temperature rise (ΔT : 40°C typ.) max

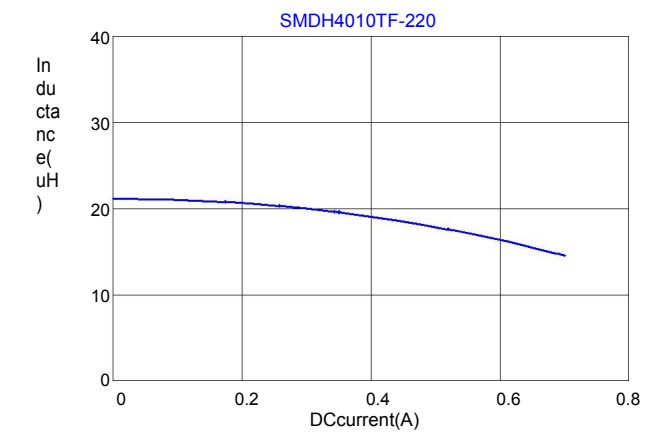
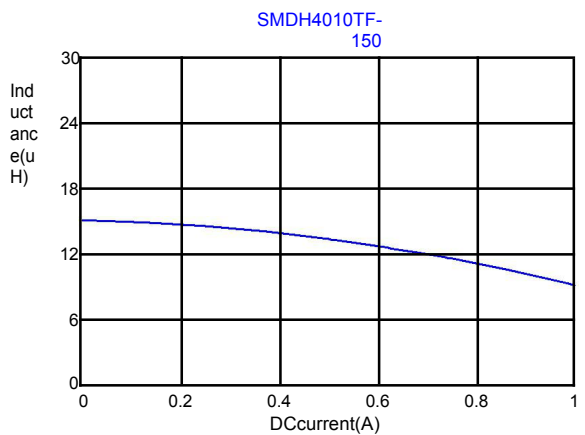
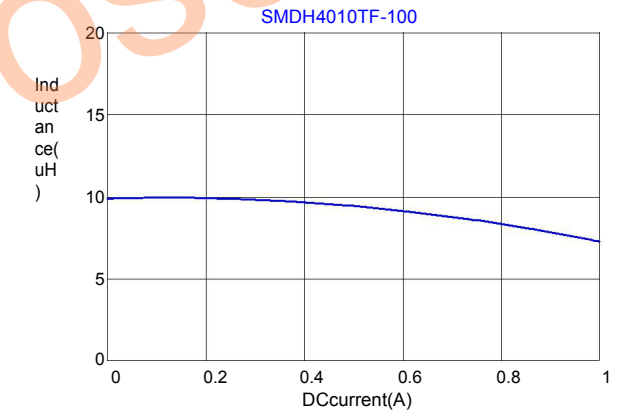
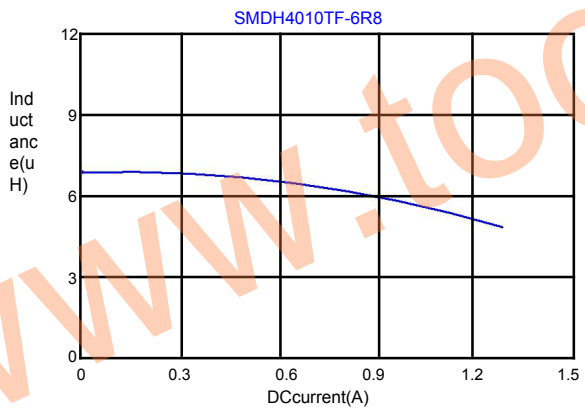
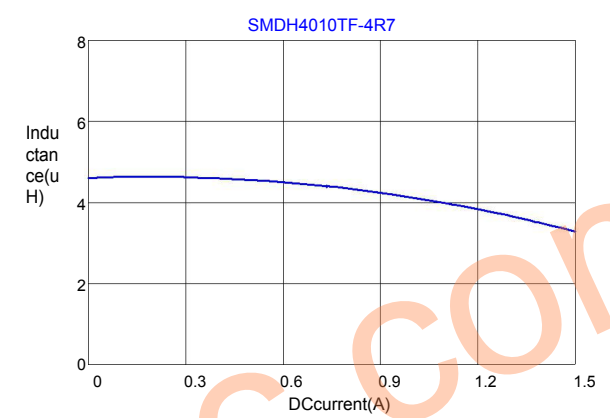
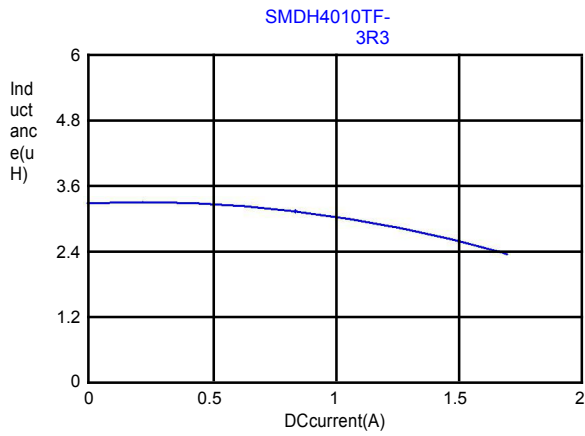
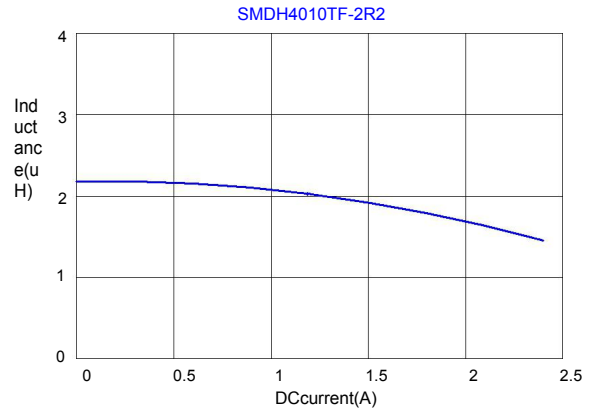
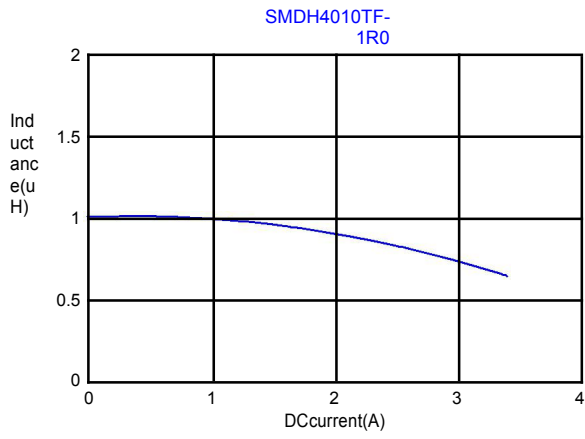

# Power Inductor

**SMDH4012TF-SERIES**

## 1. Features

1. This specification applies Low Profile Power Inductors.
2. 100% Lead(Pb) & Halogen-Free and RoHS compliant.



## 2. Dimension

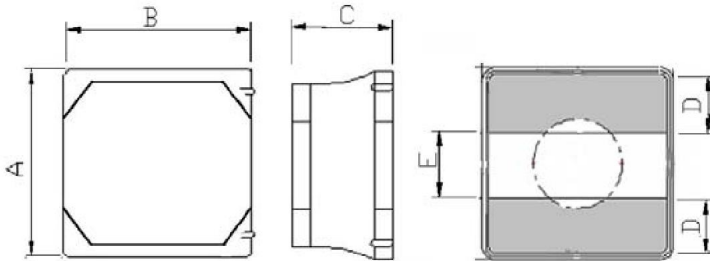

Series	A(mm)	B(mm)	C(mm)	D(mm)	E(mm)
SMDH4012TF	4.0±0.2	4.0±0.2	1.2 max.	1.2 ref.	1.6 ref.

Units: mm

## 3. Part Numbering

**SMDH**   **4012**   **TF**   -   **100**   **M**

A                      B                      C                      D                      E

A: Series

B: Dimension

C: Lead Free

D: Inductance

E: Inductance Tolerance

100=10uH

M=±20% ; Y=±30%

## 4. Specification

TOCOET Part Number	Inductance (uH)	Tolerance (%)	Test Frequency (Hz)	SRF (MHz) typ.	DCR (Ω) ±20%	I sat (A)typ.	I sat (A)Max.	I rms (A)typ.	I rms (A)Max.
SMDH4012TF -1R0Y	1.0	±30%	1V100K	100	0.042	3.30	2.80	2.50	2.20
SMDH4012TF -2R2M	2.2	±20%	1V100K	70	0.060	1.95	1.65	2.20	1.90
SMDH4012TF -3R3M	3.3	±20%	1V100K	60	0.070	1.60	1.40	1.90	1.70
SMDH4012TF -4R7M	4.7	±20%	1V100K	45	0.095	1.40	1.20	1.70	1.50
SMDH4012TF -6R8M	6.8	±20%	1V100K	35	0.125	1.10	0.90	1.50	1.30
SMDH4012TF -100M	10	±20%	1V100K	30	0.180	1.00	0.80	1.30	1.10
SMDH4012TF -150M	15	±20%	1V100K	24	0.260	0.80	0.65	0.95	0.75
SMDH4012TF -220M	22	±20%	1V100K	18	0.400	0.60	0.50	0.72	0.62

Note:

I<sub>sat</sub> : Based on inductance change (ΔL/L0 : ≤30%) @ ambient temp. 25°C

I<sub>rms</sub> : Based on temperature rise (ΔT : 40°C typ.) max

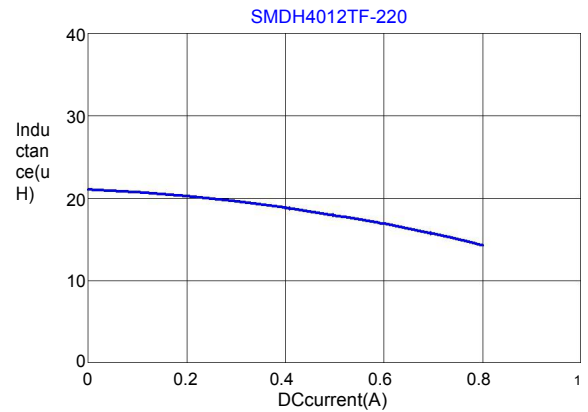
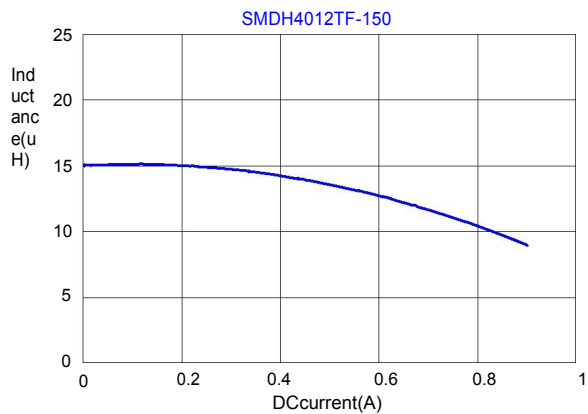
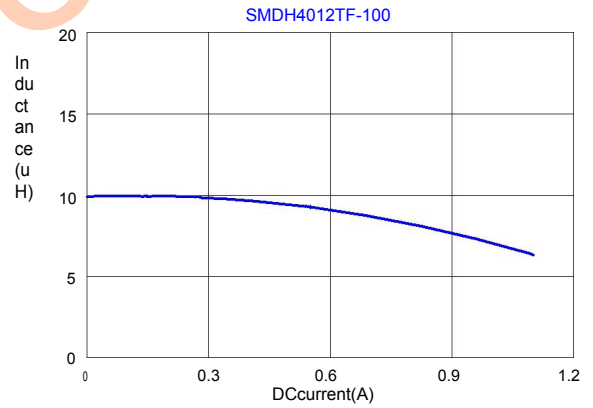
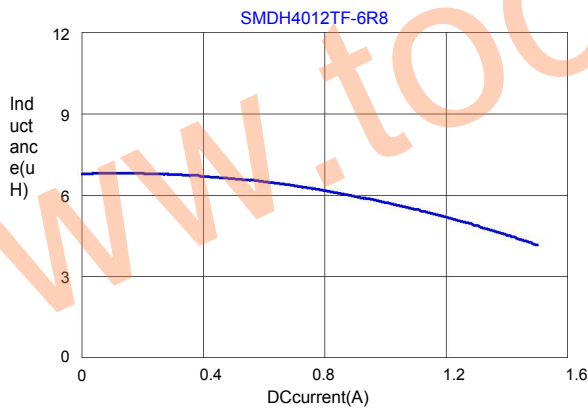
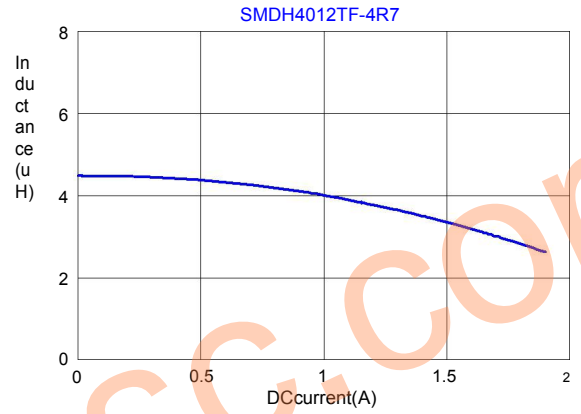
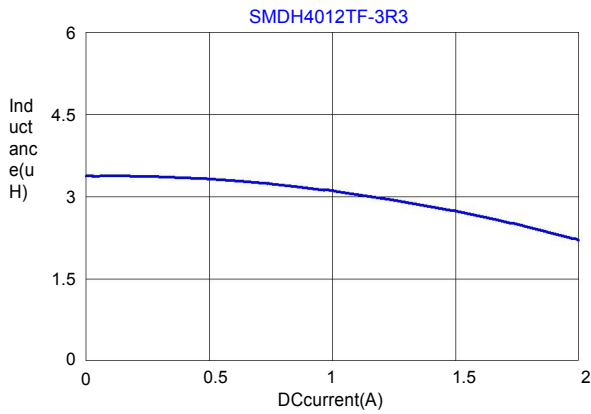
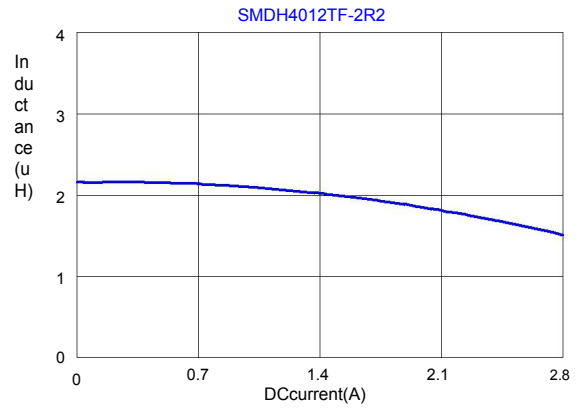
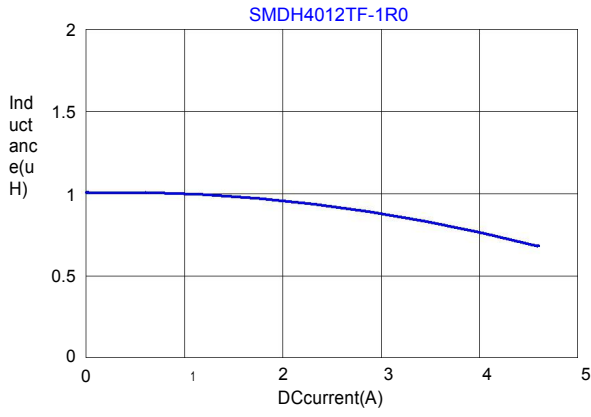

**Power Inductor** **SMDH4018NF-SERIES**

**1. Features**

- 1. This specification applies Low Profile Power Inductors.
- 2. 100% Lead(Pb) & Halogen-Free and RoHS compliant.

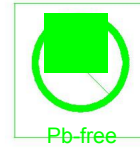

**2. Dimension**

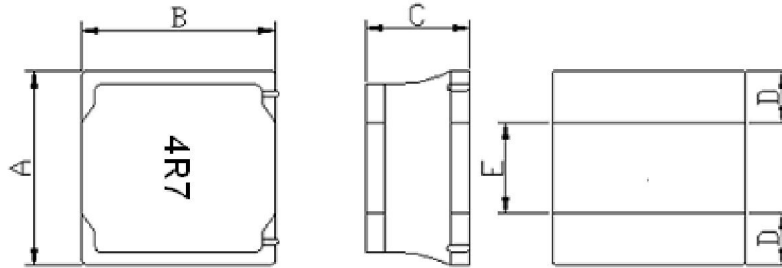

Series	A(mm)	B(mm)	C(mm)	D(mm)	E(mm)
SMDH4018NF	4.0±0.2	4.0±0.2	1.8 max.	1.2 ref.	1.6 ref.

Units: mm

**3. Part Numbering**

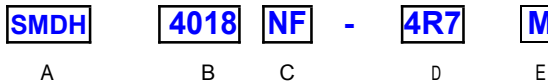

- A: Series
- B: Dimension
- C: Lead Free
- D: Inductance
- E: Inductance Tolerance

4R7=4.7uH  
M=±20% Y=±30%

**4. Specification**

TOCOET Part Number	Inductance (uH)	Tolerance (%)	Test Frequency (Hz)	SRF (MHz) typ.	DCR (Ω) ±20%	I sat (A)typ.	I sat (A)Max.	I rms (A)typ.	I rms (A)Max.
SMDH4018NF-1R0M	1.0	±20%	1V100K	160	0.027	4.00	3.60	3.70	3.60
SMDH4018NF-1R5M	1.5	±20%	1V100K	110	0.032	3.30	3.00	3.30	3.00
SMDH4018NF-2R2M	2.2	±20%	1V100K	70	0.042	3.00	2.70	2.90	2.70
SMDH4018NF-3R3M	3.3	±20%	1V100K	60	0.055	2.30	2.20	2.30	2.20
SMDH4018NF-4R7M	4.7	±20%	1V100K	50	0.070	2.00	1.90	2.00	1.90
SMDH4018NF-6R8M	6.8	±20%	1V100K	40	0.098	1.70	1.60	1.70	1.60
SMDH4018NF-100M	10	±20%	1V100K	35	0.150	1.50	1.40	1.50	1.40
SMDH4018NF-150M	15	±20%	1V100K	25	0.190	1.10	1.00	1.10	1.00
SMDH4018NF-220M	22	±20%	1V100K	20	0.290	0.90	0.80	0.90	0.80
SMDH4018NF-330M	33	±20%	1V100K	12	0.405	0.75	0.70	0.75	0.70
SMDH4018NF-470M	47	±20%	1V100K	10	0.550	0.60	0.55	0.60	0.55

Note:

I<sub>sat</sub> : Based on inductance change (ΔL/L0 : ≤30%) @ ambient temp. 25°C

I<sub>rms</sub> : Based on temperature rise (ΔT : 40°C.) Max

# TOCOET

TOCOET Part Number	Inductance (uH)	Tolerance (%)	Test Frequency (Hz)	SRF (MHz) typ.	DCR ( $\Omega$ ) $\pm 20\%$	I sat (A)typ.	I sat (A)Max.	I rms (A)typ.	I rms (A)Max.
SMDH4018NF-680M	68	$\pm 20\%$	1V100K	10	0.890	0.55	0.50	0.55	0.50
SMDH4018NF-101M	100	$\pm 20\%$	1V100K	8	1.380	0.45	0.40	0.45	0.40
SMDH4018NF-151M	150	$\pm 20\%$	1V100K	5	1.970	0.35	0.30	0.35	0.30
SMDH4018NF-221M	220	$\pm 20\%$	1V100K	5	3.000	0.30	0.25	0.30	0.25

Note:

I<sub>sat</sub> : Based on inductance change ( $\Delta L/L_0 : \leq 30\%$ ) @ ambient temp. 25°C

I<sub>rms</sub> : Based on temperature rise ( $\Delta T : 40^\circ\text{C}.$ ) Max

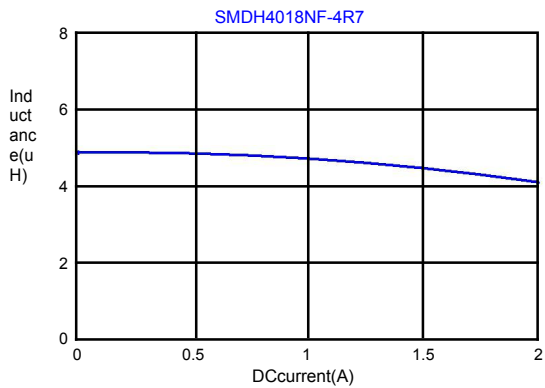
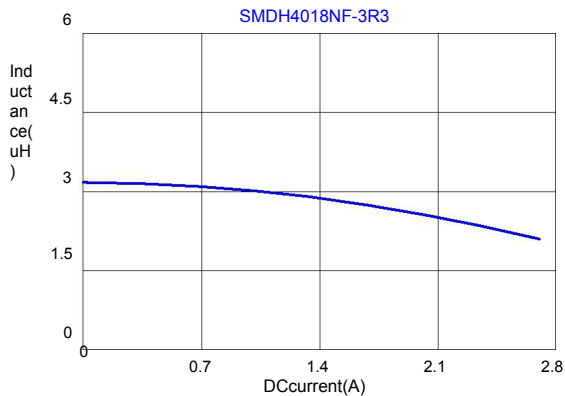
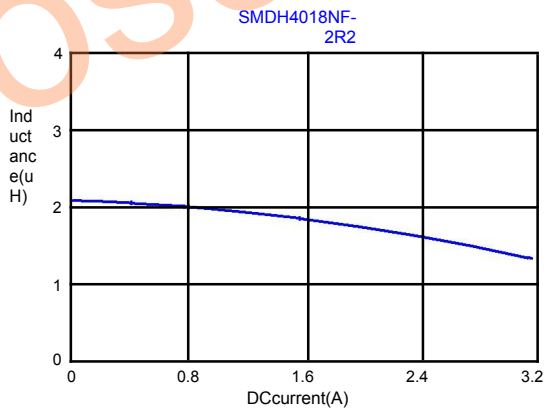
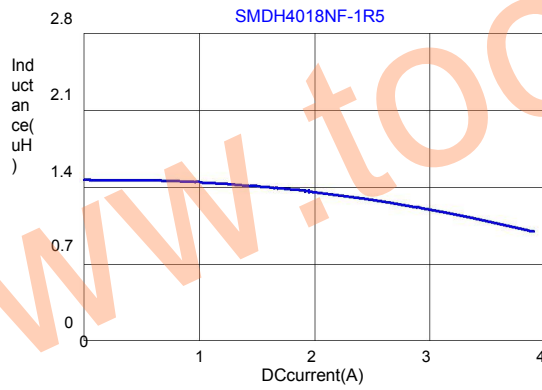
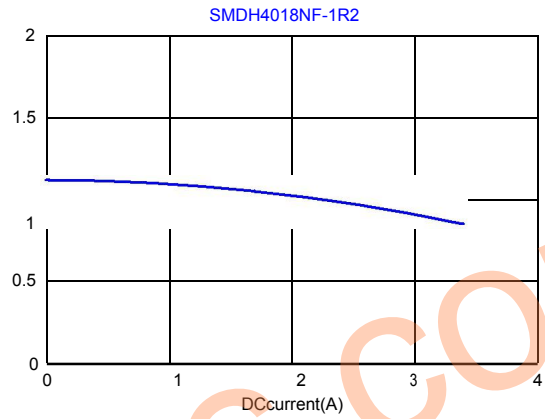
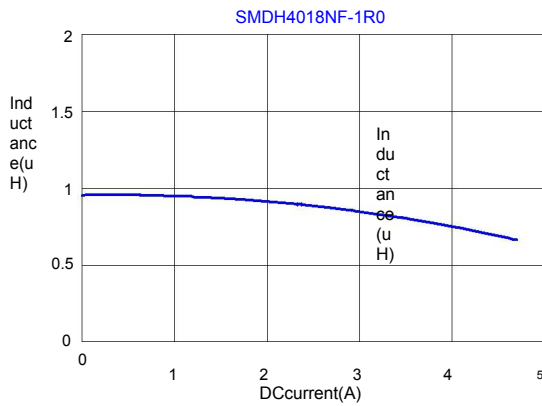

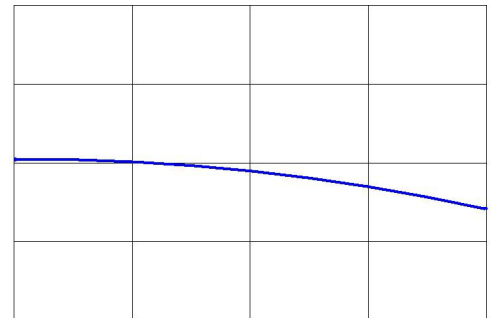
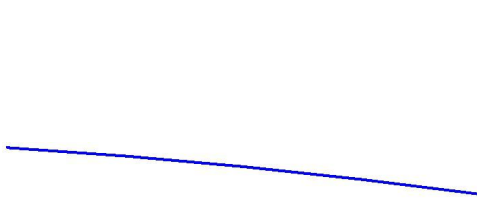
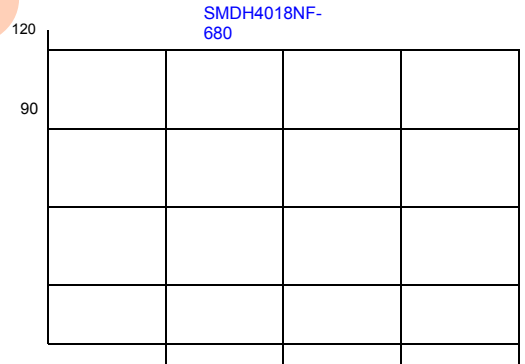
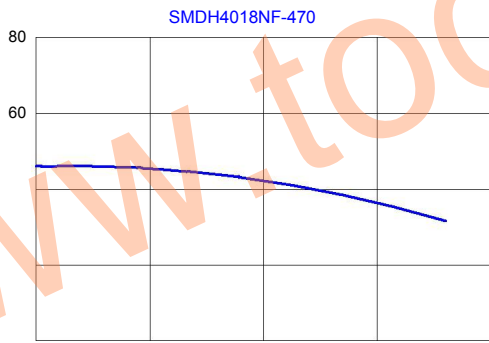
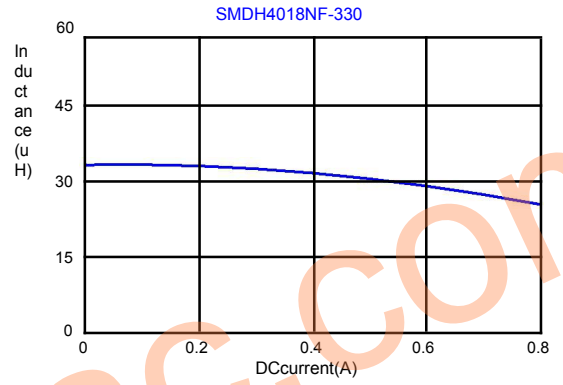
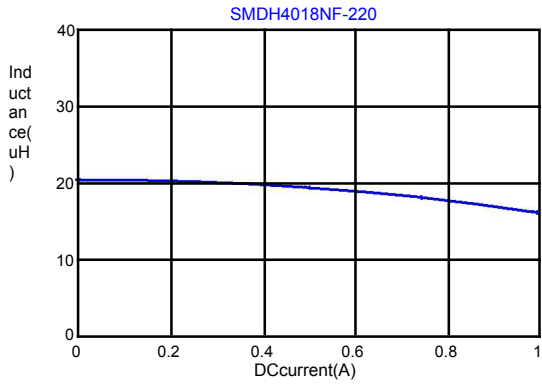
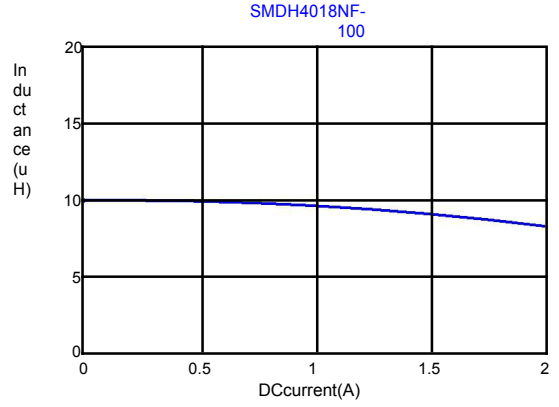
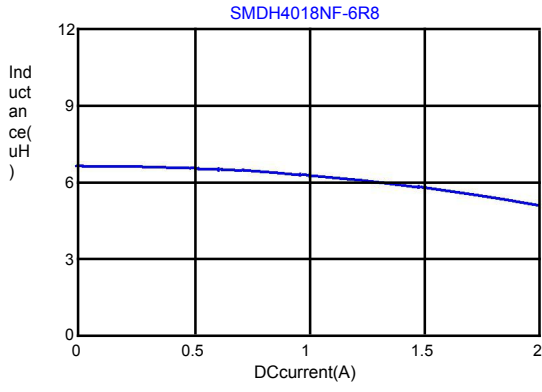

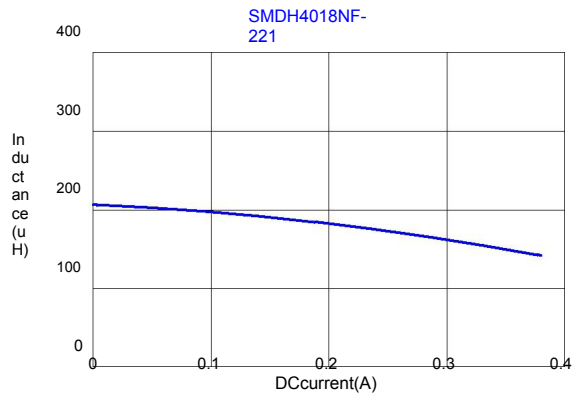

www.tocosc.com



**SMD Power Inductor** **SMDH4030NF-Series**

**1. Features**

1. Magnetic-resin shielded construction reduces buzz noise to ultra-low levels
2. Metallization on ferrite core results in excellent shock resistance and damage-free durability
3. Closed magnetic circuit design reduces leakage flux and Electro Magnetic Interference (EMI)
4. 30% higher current rating than conventional inductors of equal size
5. Takes up less PCB real estate and save more power



**2. Applications**

1. LED Lighting
2. Next-generation mobile devices with multifunction such as mobile TV and digital movie cameras
3. Flat-screen TVs, blue-ray disc recorders, set top box
4. Notebooks, desktop computers, servers, graphic cards cards
5. Portable gaming devices, personal navigation systems, personal multimedia devices
6. Automotive systems
7. Telecomm base stations

**3. Dimension**

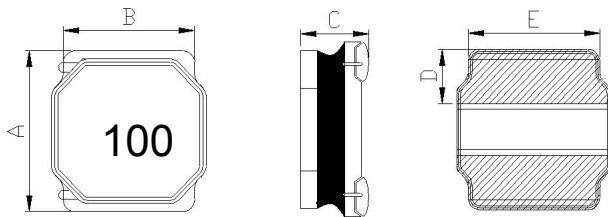

Series	*A(mm)	*B(mm)	C(mm)	D(mm)	E(mm)
SMDH4030NF	4.0±0.2	4.0±0.2	3.0Max.	1.35±0.3	3.4±0.2

\*Dimensions are not including the termination. For maximum overall dimensions with termination, add 0.1mm.

**Recommended Land pattern**

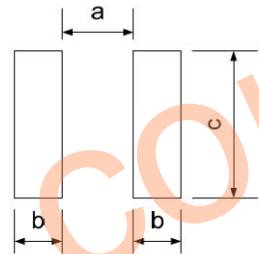

a(mm)	b(mm)	c(mm)
1.3Typ	1.5Typ	3.7Typ

Note: 1. The above PCB layout reference only. 2. Recommend solder paste thickness at 0.12mm and above.

**4. Part Numbering**



A: Series  
 B: Dimension A/B\*C  
 C: Type  
 D: Inductance 1R0=1.00uh, 100=10uh, 101=100uh, 102=1000uh  
 E: Inductance Tolerance K=±10%, L=±15%, M=±20%, Y=±30%.  
 marking direction cannot decide polarity. Color: Black, unidirectional magnetic shielding

## 5. Specification

Part Number	Inductance L0 (uH)±20% @ 0 A	Rated current		DCR (mΩ) @25℃ ±20%.
		Temperature current I rms (A)	Saturation current I sat (A)	
SMDH4030NF-R68M	0.68	4.60	6.80	10
SMDH4030NF-1R0M	1.00	4.20	5.30	14
SMDH4030NF-1R5M	1.50	3.40	4.90	20
SMDH4030NF-2R2M	2.20	3.00	4.90	30
SMDH4030NF-3R3M	3.30	2.40	3.30	40
SMDH4030NF-4R7M	4.70	2.05	2.90	60
SMDH4030NF-5R6M	5.60	1.95	2.60	65
SMDH4030NF-6R8M	6.80	1.80	2.75	90
SMDH4030NF-8R2M	8.20	1.60	2.10	90
SMDH4030NF-100M	10.0	1.50	2.00	100
SMDH4030NF-120M	12.0	1.30	1.80	135
SMDH4030NF-150M	15.0	1.20	1.70	190
SMDH4030NF-180M	18.0	1.10	1.50	200
SMDH4030NF-220M	22.0	1.00	1.30	225
SMDH4030NF-330M	33.0	0.85	1.10	330
SMDH4030NF-470M	47.0	0.72	0.95	445

Note:

1. All test data referenced to 25℃ ambient , Ls:100KHz/1V.
2. Testing Instrument : HP4284A,CH11025,CH3302,CH1320 ,CH1320S LCR METER / Rdc:CH502BC MICRO OHMMETER.
3. Heat Rated Current (I rms) will cause the coil temperature rise approximately 10℃ at of 40℃.
4. Saturation Current ( I sat ) will cause L0 to drop approximately 30%.
5. The part temperature (ambient + temp rise) should not exceed 125℃under worst case operating conditions.Circuit design,component,PCB trace size and thickness,airflow and other cooling provisions all affect the part temperature. Part temperature should be verified in the end application.
6. Special inquiries besides the above common used types can be met on your requirement.

### 6. Typical Performance Curve

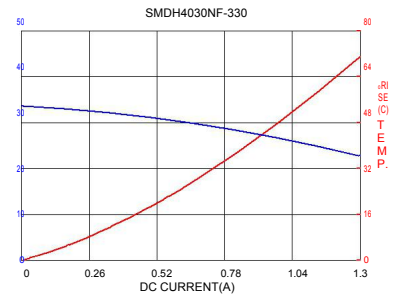
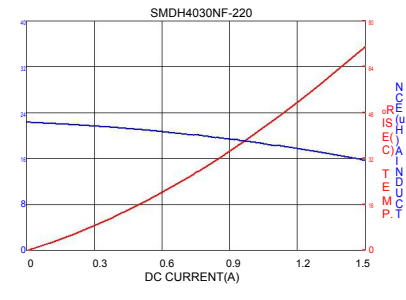
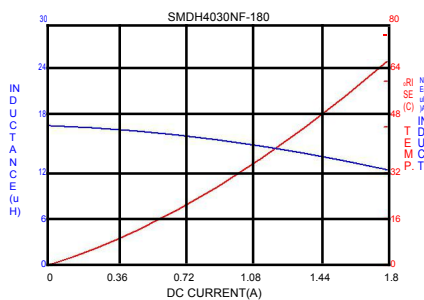
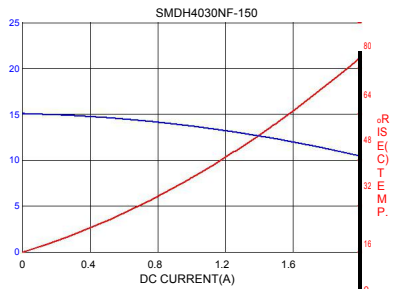
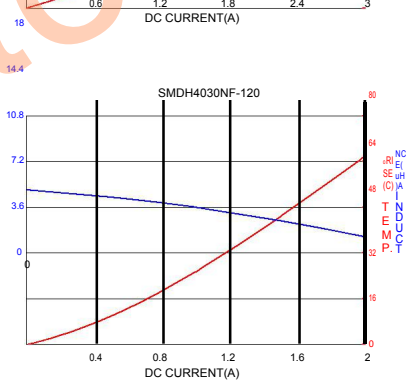
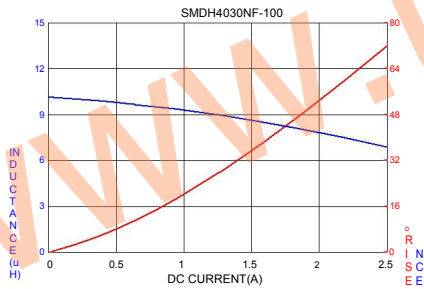
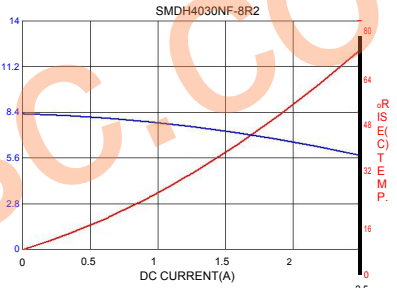
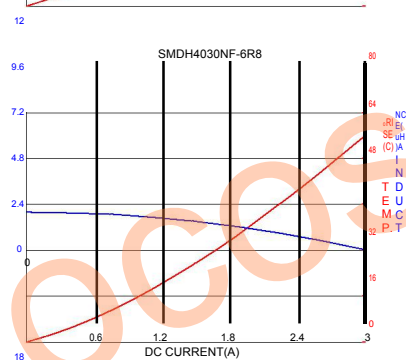
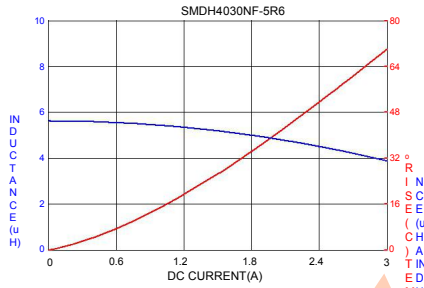
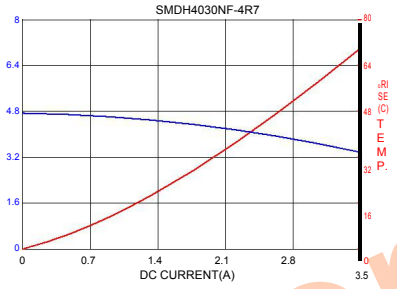
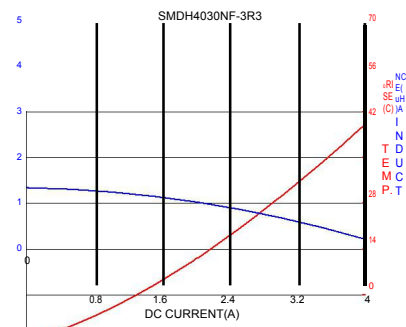
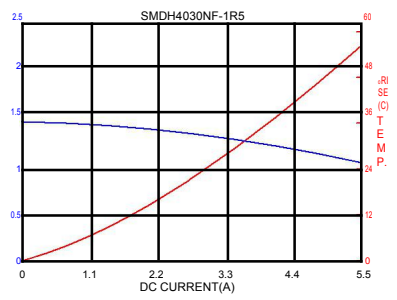
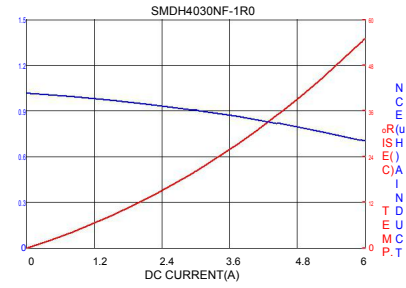
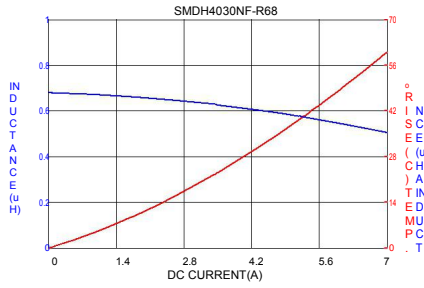

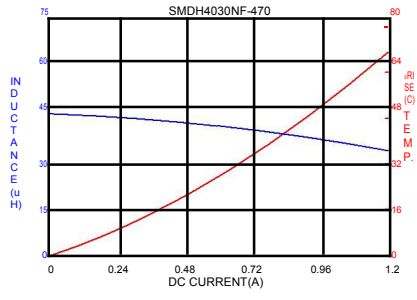

www.tocos.com

**Power Inductor** **SMDH5010B-Series**

**1. Features**

- 1. This specification applies Low Profile Power Inductors.
- 2. 100% Lead(Pb) & Halogen-Free and RoHS compliant.

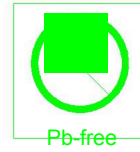

**2. Dimension**

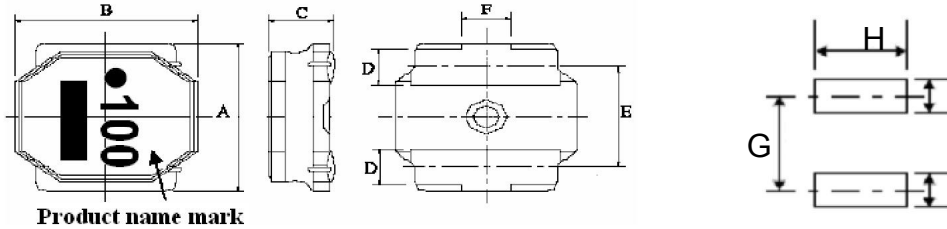

Series	A(mm)	B(mm)	C(mm)	D(mm)	E(mm)	F(mm)	G(mm)	H(mm)	I(mm)
SMDH5010B	4.9±0.2	4.9±0.2	1.0 max.	1.2±0.2	3.3±0.2	1.3 typ.	3.6 ref.	4.0 ref.	1.5 ref.

Units: mm

**3. Part Numbering**

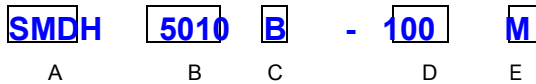

- A: Series
- B: Dimension
- C: Control S/N
- D: Inductance  
100=10.0uH
- E: Inductance Tolerance  
M=±20% ; Y=±30%

**4. Specification**

TOCOET Part Number	Inductance (uH)	Tolerance (%)	Test Frequency (Hz)	SRF (MHz) min.	DCR (Ω) ±20%	I sat (A)	I rms (A)
SMDH5010B-1R0Y	1.0	±30%	1V100K	95	0.070	2.35	1.75
SMDH5010B-2R2Y	2.2	±30%	1V100K	65	0.105	1.50	1.40
SMDH5010B-3R3M	3.3	±20%	1V100K	42	0.125	1.40	1.25
SMDH5010B-4R7M	4.7	±20%	1V100K	37	0.145	1.20	1.15
SMDH5010B-6R8M	6.8	±20%	1V100K	33	0.185	1.00	1.00
SMDH5010B-100M	10	±20%	1V100K	23	0.250	0.85	0.90
SMDH5010B-150M	15	±20%	1V100K	19	0.400	0.68	0.65
SMDH5010B-220M	22	±20%	1V100K	15	0.600	0.55	0.45

Note:

- I<sub>sat</sub> : Based on inductance change (ΔL/L0 : ≤-30%) @ ambient temp. 25°C
- I<sub>rms</sub> : Based on temperature rise (ΔT : 40°C typ.)

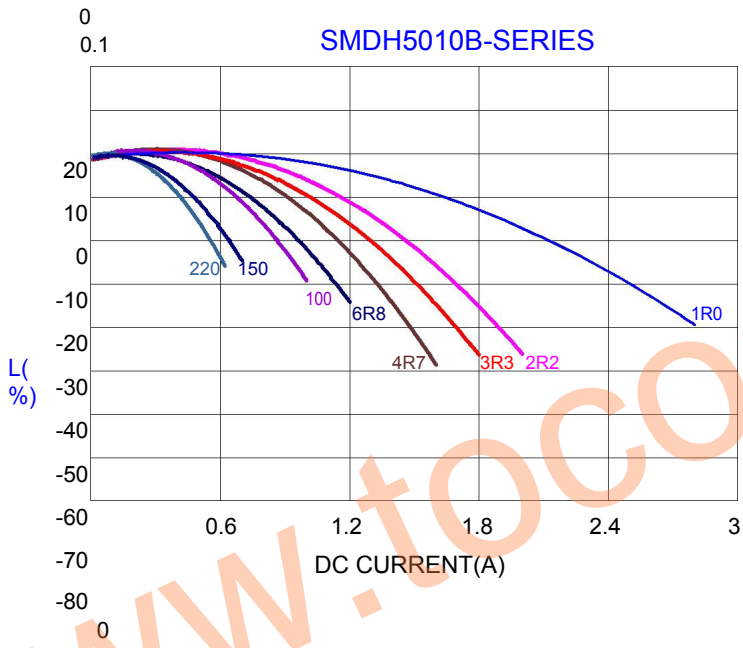
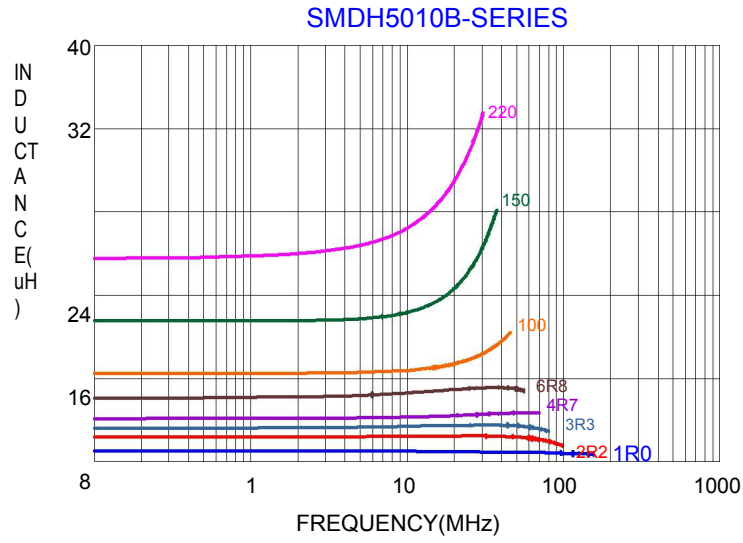

<b>Power Inductor</b>	<b>SMDH5012B-SERIES</b>
-----------------------	-------------------------

### 1. Features

1. This specification applies Low Profile Power Inductors.
2. 100% Lead(Pb) & Halogen-Free and RoHS compliant.



### 2. Dimension

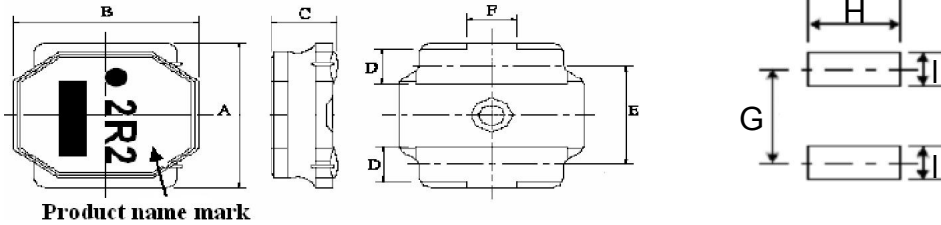

Series	A(mm)	B(mm)	C(mm)	D(mm)	E(mm)	F(mm)	G(mm)	H(mm)	I(mm)
SMDH5012B	4.9±0.2	4.9±0.2	1.2 max.	1.2±0.2	3.3±0.2	1.3 typ.	3.6 ref.	4.0 ref.	1.5 ref.

Units: mm

### 3. Part Numbering

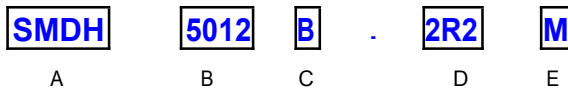

- A: Series
- B: Dimension
- C: Control S/N
- D: Inductance                            2R2=2.2uH
- E: Inductance Tolerance                M=±20% ; Y=±30%

### 4. Specification

TOCOET Part Number	Inductance (uH)	Tolerance (%)	Test Frequency (Hz)	SRF (MHz) min.	DCR (Ω) ±20%	I sat (A)	I rms (A)
SMDH5012B-1R0Y	1.0	±30%	1V100K	100	0.053	4.50	2.30
SMDH5012B-1R5Y	1.5	±30%	1V100K	86	0.070	3.80	2.20
SMDH5012B-2R2M	2.2	±20%	1V100K	70	0.085	3.10	2.00
SMDH5012B-3R3M	3.3	±20%	1V100K	48	0.160	2.40	1.45
SMDH5012B-4R7M	4.7	±20%	1V100K	40	0.180	2.20	1.40
SMDH5012B-6R8M	6.8	±20%	1V100K	36	0.260	1.70	1.10
SMDH5012B-100M	10	±20%	1V100K	26	0.420	1.40	0.85
SMDH5012B-150M	15	±20%	1V100K	22	0.670	1.20	0.64

Note:

I<sub>sat</sub> : Based on inductance change ( ΔL/L0 : ≤-30% ) @ ambient temp. 25°C

I<sub>rms</sub> : Based on temperature rise ( ΔT : 40°C typ. )

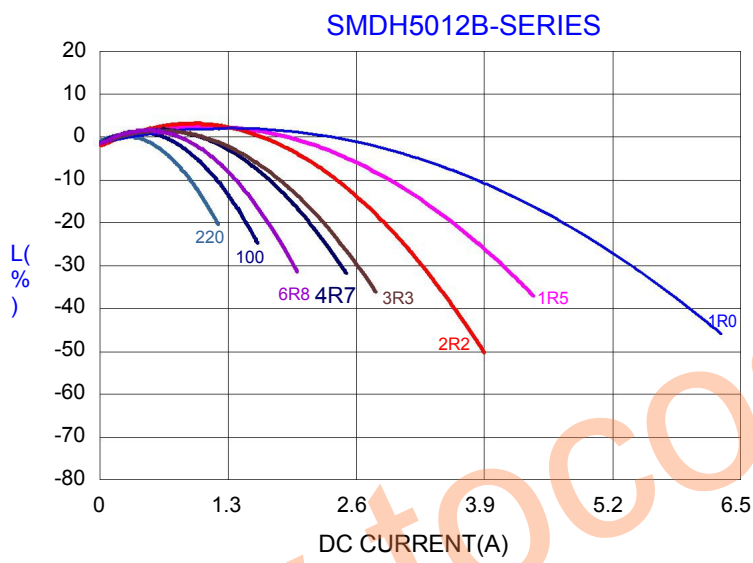
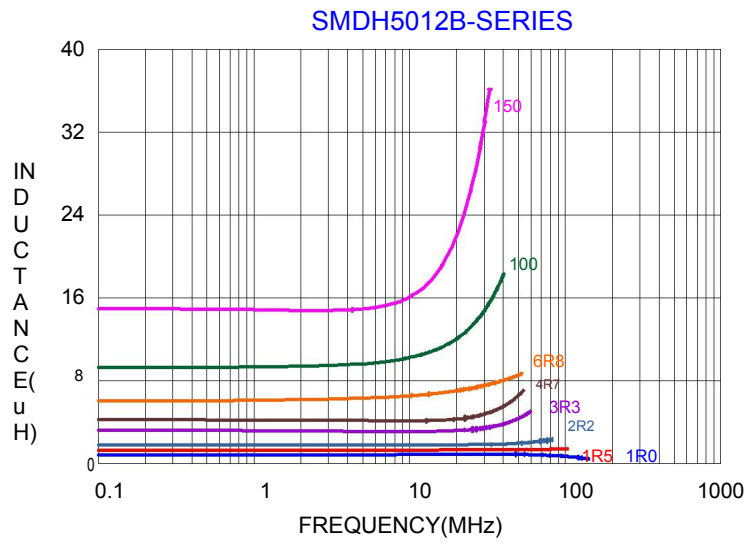



# Power Inductor

**SMDH5014B-SERIES**

## 1. Features

1. This specification applies Low Profile Power Inductors.
2. 100% Lead(Pb) & Halogen-Free and RoHS compliant.



## 2. Dimension

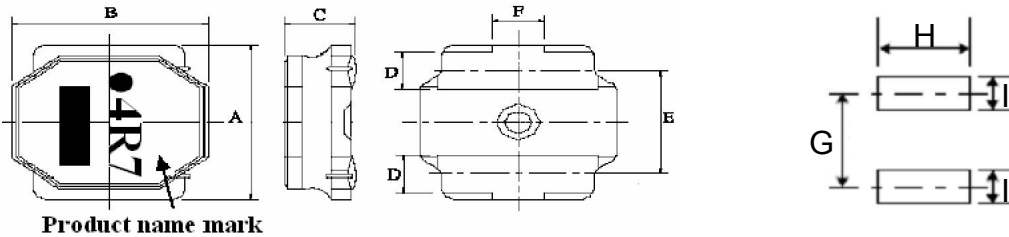

Series	A(mm)	B(mm)	C(mm)	D(mm)	E(mm)	F(mm)	G(mm)	H(mm)	I(mm)
SMDH5014B	4.9±0.2	4.9±0.2	1.4 max.	1.2±0.2	3.3±0.2	1.3 typ.	3.6 ref.	4.0 ref.	1.5 ref.

Units: mm

## 3. Part Numbering

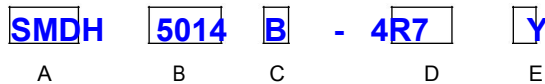

- A: Series  
 B: Dimension  
 C: Control S/N  
 D: Inductance                      4R7=4.7uH  
 E: Inductance Tolerance            M=±20% ; Y=±30%

## 4. Specification

TOCOET Part Number	Inductance (uH)	Tolerance (%)	Test Frequency (Hz)	SRF (MHz) min.	DCR (Ω) ±20%	I sat (A)	I rms (A)
SMDH5014B-R47Y	0.47	±30%	1V100K	185	0.025	5.80	3.30
SMDH5014B-1R2Y	1.2	±30%	1V100K	86	0.045	3.80	2.40
SMDH5014B-2R2Y	2.2	±30%	1V100K	56	0.065	2.80	2.00
SMDH5014B-3R3Y	3.3	±30%	1V100K	48	0.080	2.35	1.70
SMDH5014B-4R7Y	4.7	±30%	1V100K	41	0.100	2.05	1.40
SMDH5014B-6R8M	6.8	±20%	1V100K	33	0.150	1.60	1.20
SMDH5014B-100M	10	±20%	1V100K	27	0.200	1.40	1.05
SMDH5014B-150M	15	±20%	1V100K	20	0.320	1.1	0.65
SMDH5014B-220M	22	±20%	1V100K	16	0.450	0.9	0.55

I<sub>sat</sub> : Based on inductance change (ΔL/L0 : ≤-30%) @ ambient temp. 25°C  
 I<sub>rms</sub> : Based on temperature rise (ΔT : 40°C typ.)

SMDH5014B-SERIES

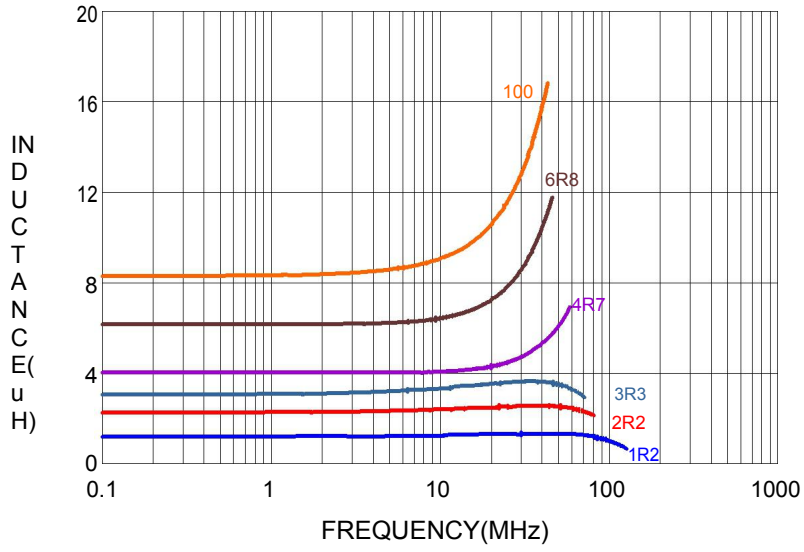

SMDH5014B-SERIES

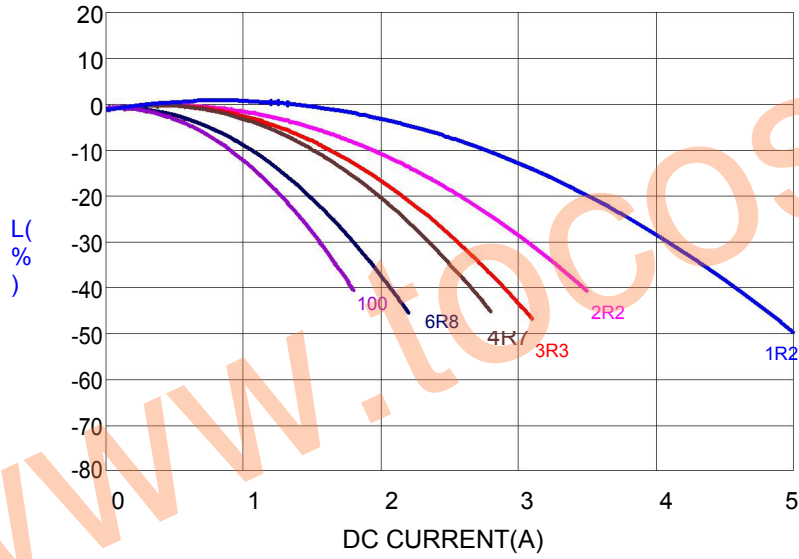

**SMD Power Inductor** **SMDH5020NF-Series**

**1. Features**

- 1. This specification applies Low Profile Power Inductors.
- 2. 100% Lead(Pb) & Halogen-Free and RoHS compliant.



**1. Dimension**

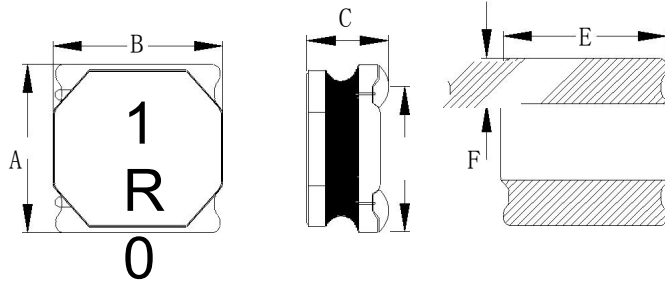

**Recommended Land pattern**

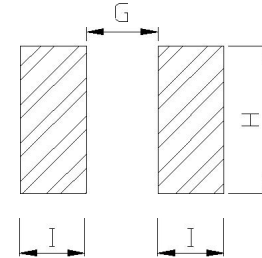

Series	*A(mm)	*B(mm)	*C(mm)	D(mm)	E(mm)	F(mm)
SMDH5020NF	5.0±0.2	5.0±0.2	1.8±0.2	1.3±0.2	4.7±0.2	3.7ref

\*Dimensions are not including the termination. For maximum overall dimensions with termination, add 0.1mm.

G(mm)	H(mm)	I(mm)
2.1	4.7	1.5

Note: 1. The above PCB layout reference only.  
2. Recommend solder paste thickness at 0.12mm and above.

**3. Part Numbering**



- A: Series
- B: Dimension
- C: Type
- D: Inductance
- E: Inductance Tolerance

A/B\*C

1R0=1.00uh 100=10uh, 101=100uh, 102=1000uh  
K=± 10%, L=±15%, M=±20%, Y=± 30%.

marking direction cannot decide polarity. Color: Black, unidirectional.  
magnetic shielding

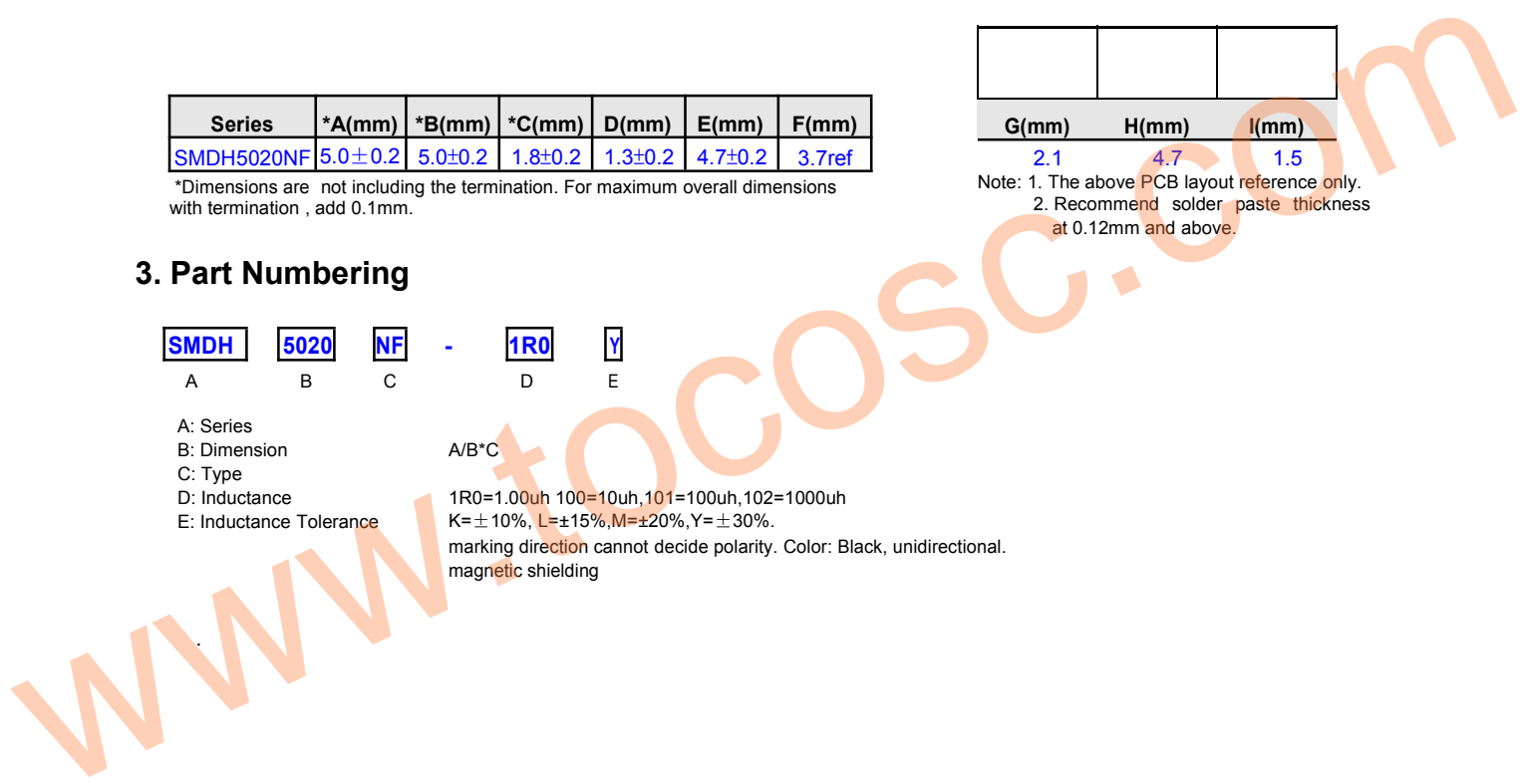

## 4. Specification

Part Number	Inductance L0 (uH) @ 0 A	Tolerance	Rated current		DCR (mΩ) @25°C ±20%.
			Temperature current I rms (A)	Saturation current I sat (A)	
SMDH5020NF-1R0Y	1.00	±30%	4.10	5.00	20
SMDH5020NF-1R2Y	1.20	±30%	3.80	4.80	20
SMDH5020NF-1R5Y	1.50	±30%	3.50	4.50	25
SMDH5020NF-2R2M	2.20	±20%	3.30	4.10	32
SMDH5020NF-2R7M	2.70	±20%	3.00	3.80	38
SMDH5020NF-3R3M	3.30	±20%	2.80	3.50	43
SMDH5020NF-4R7M	4.70	±20%	2.40	2.70	60
SMDH5020NF-5R6M	5.60	±20%	2.10	2.40	69
SMDH5020NF-6R8M	6.80	±20%	1.90	2.10	90
SMDH5020NF-8R2M	8.20	±20%	1.75	1.90	98
SMDH5020NF-100M	10.0	±20%	1.60	1.70	110
SMDH5020NF-120M	12.0	±20%	1.40	1.40	135
SMDH5020NF-150M	15.0	±20%	1.25	1.30	165
SMDH5020NF-180M	18.0	±20%	1.17	1.20	190
SMDH5020NF-220M	22.0	±20%	1.10	1.10	225
SMDH5020NF-330M	33.0	±20%	0.80	0.80	335
SMDH5020NF-470M	47.0	±20%	0.70	0.70	460

Note:

1. All test data referenced to 25°C ambient, Ls/Q:100KHz/1V.
2. Testing Instrument(or equ) : L: HP4284A,CH11025,CH3302,CH1320,CH1320S LCR METER / Rdc:CH16502,Agilent33420A MICRO OHMMETER.
3. Heat Rated Current (I rms) will cause the coil temperature rise approximately T of 40°C
4. Saturation Current (Isat) will cause L0 to drop approximately 30%.
5. The part temperature (ambient + temp rise) should not exceed 125°C under worst case operating conditions. Circuit design, component, PCB trace size and thickness, airflow and other cooling provisions all affect the part temperature. Part temperature should be verified in the end application.
7. Special inquiries besides the above common used types can be met on your requirement.

### 5. Typical Performance Curves

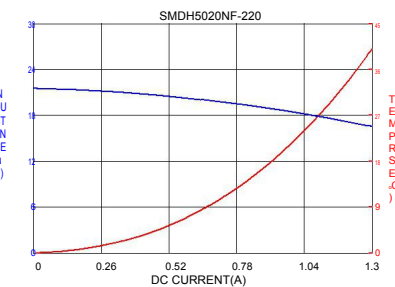
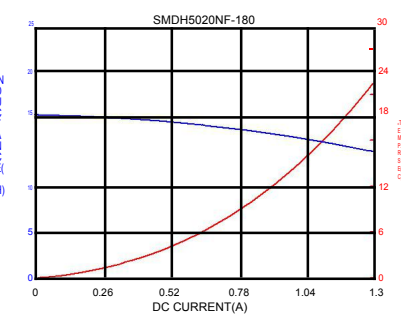
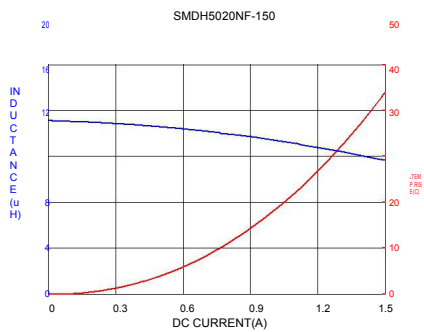
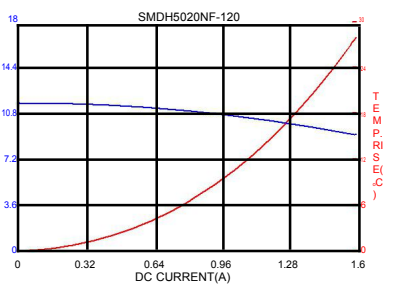
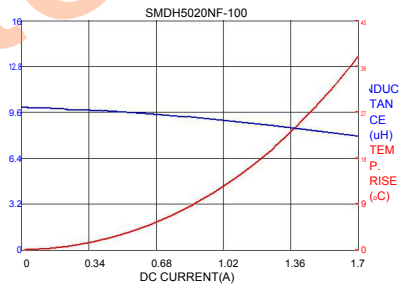
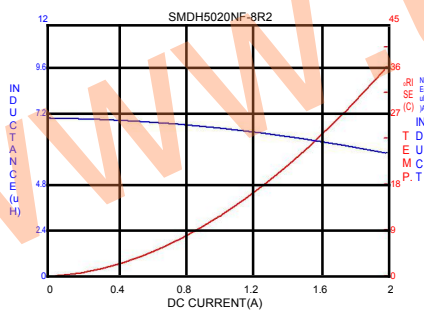
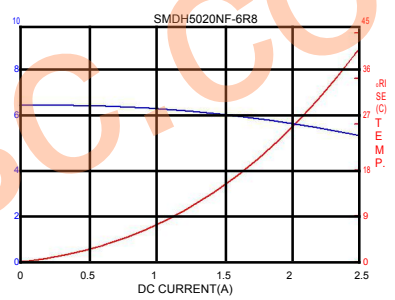
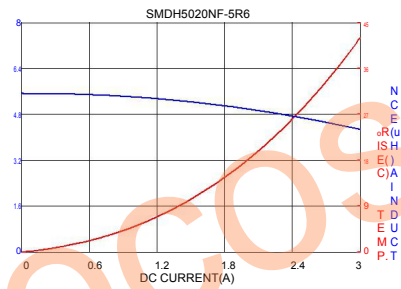
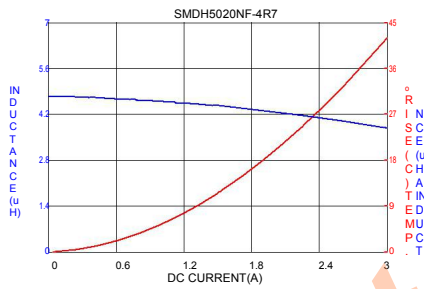
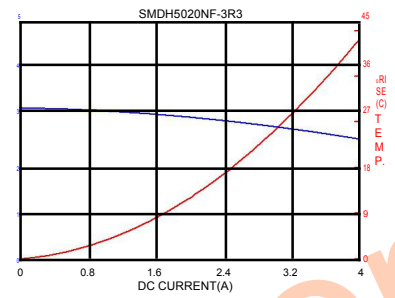
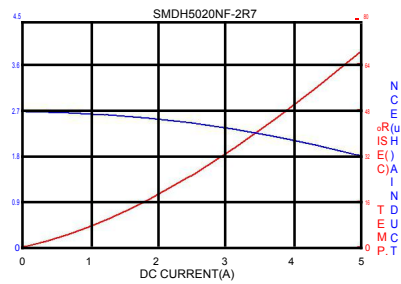
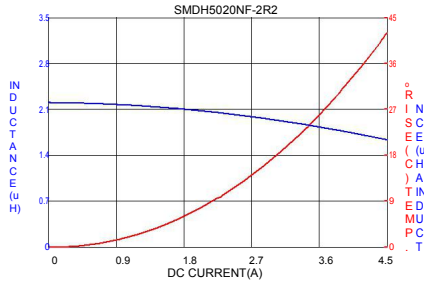
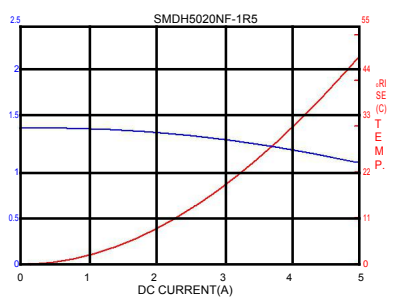
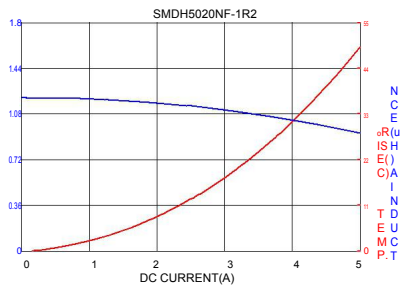
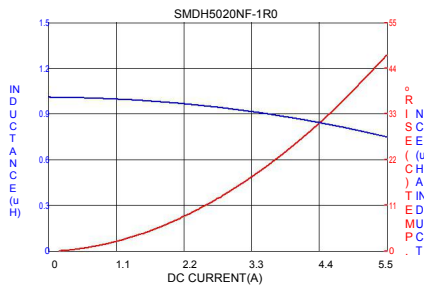

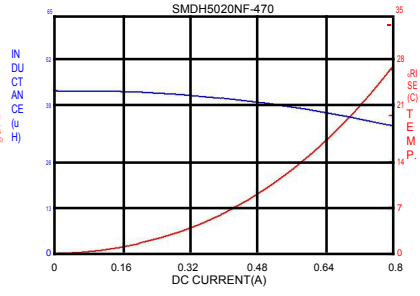
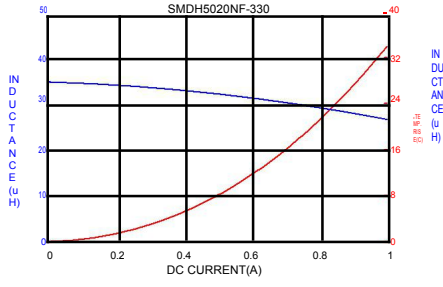

www.tocos.com

# Power Inductor

SMDH5024B-Series

## 1. Features

1. This specification applies Low Profile Power Inductors.
2. 100% Lead(Pb) & Halogen-Free and RoHS compliant.



## 2. Dimension

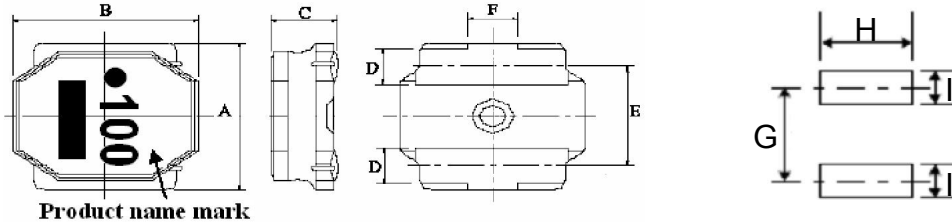

Series	A(mm)	B(mm)	C(mm)	D(mm)	E(mm)	F(mm)	G(mm)	H(mm)	I(mm)
SMDH5024B	4.9±0.2	4.9±0.2	2.4 max.	1.2±0.2	3.3±0.2	1.3 typ.	3.6 ref.	4.0 ref.	1.5 ref.

Units: mm

## 3. Part Numbering

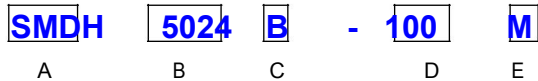

- A: Series
- B: Dimension
- C: Control S/N
- D: Inductance                      100=10.0uH
- E: Inductance Tolerance          M=±20% ; Y=±30%

## 4. Specification

TOCOET Part Number	Inductance (uH)	Tolerance (%)	Test Frequency (Hz)	SRF (MHz) min.	DCR (Ω) ±20%	I sat (A)	I rms (A)
SMDH5024B-1R0Y	1.0	±30%	1V100K	85	0.016	5.80	4.40
SMDH5024B-1R5Y	1.5	±30%	1V100K	67	0.022	5.20	3.60
SMDH5024B-2R2Y	2.2	±30%	1V100K	51	0.029	4.10	3.10
SMDH5024B-3R3Y	3.3	±30%	1V100K	41	0.043	3.10	2.40
SMDH5024B-4R7M	4.7	±20%	1V100K	37	0.055	2.70	2.00
SMDH5024B-6R8M	6.8	±20%	1V100K	28	0.080	2.20	1.60
SMDH5024B-100M	10	±20%	1V100K	21	0.125	1.70	1.20
SMDH5024B-150M	15	±20%	1V100K	18	0.170	1.40	1.00
SMDH5024B-220M	22	±20%	1V100K	15	0.230	1.20	0.82
SMDH5024B-330M	33	±20%	1V100K	11	0.370	1.00	0.63

Note:

- I<sub>sat</sub> : Based on inductance change ( ΔL/L0 : ≤-30% ) @ ambient temp. 25°C
- I<sub>rms</sub> : Based on temperature rise ( ΔT : 40°C typ. )

<b>SMD Power Inductor</b>	<b>SMDH5040NF-Series</b>
---------------------------	--------------------------

### 1. Features

1. This specification applies Low Profile Power Inductors.
2. 100% Lead(Pb) & Halogen-Free and RoHS compliant.

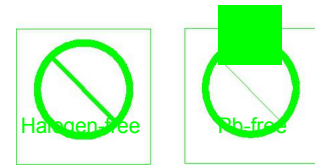

### 2. Dimension

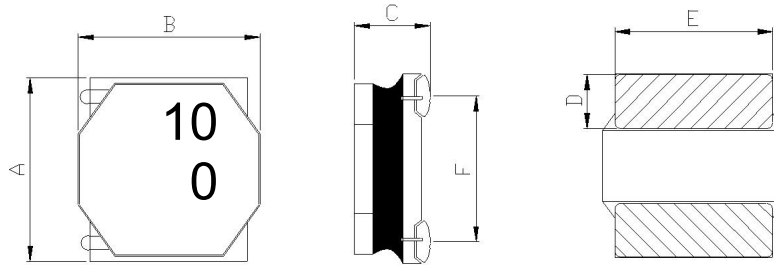

#### Recommended Land pattern

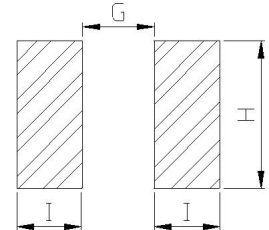

Series	Inductance	A(mm)	B(mm)	C(mm)	D(mm)	E (mm)	F(mm)
SMDH5040 NF	≤10 uH	4.95±0.2	4.95±0.2	3.9±0.2	1.3±0.3	4.2±0.2	3.7ref
	>10 uH			3.8±0.2			

G(mm)	H(mm)	I(mm)
2.1	4.2	1.5

Note:  
 1. The above PCB layout reference only.  
 2. Recommend solder paste thickness at 0.12mm and above.

### 3. Part Numbering



- A: Series
- B: Dimension
- C: Type
- D: Inductance
- E: Inductance Tolerance

A/B\*C

1R0=1.00uh 100=10uh,101=100uh,102=1000uh  
 K=±10%, L=±15%,M=±20%,Y=±30%.

marking direction cannot decide polarity. Color: Black, unidirectional.  
 magnetic shielding

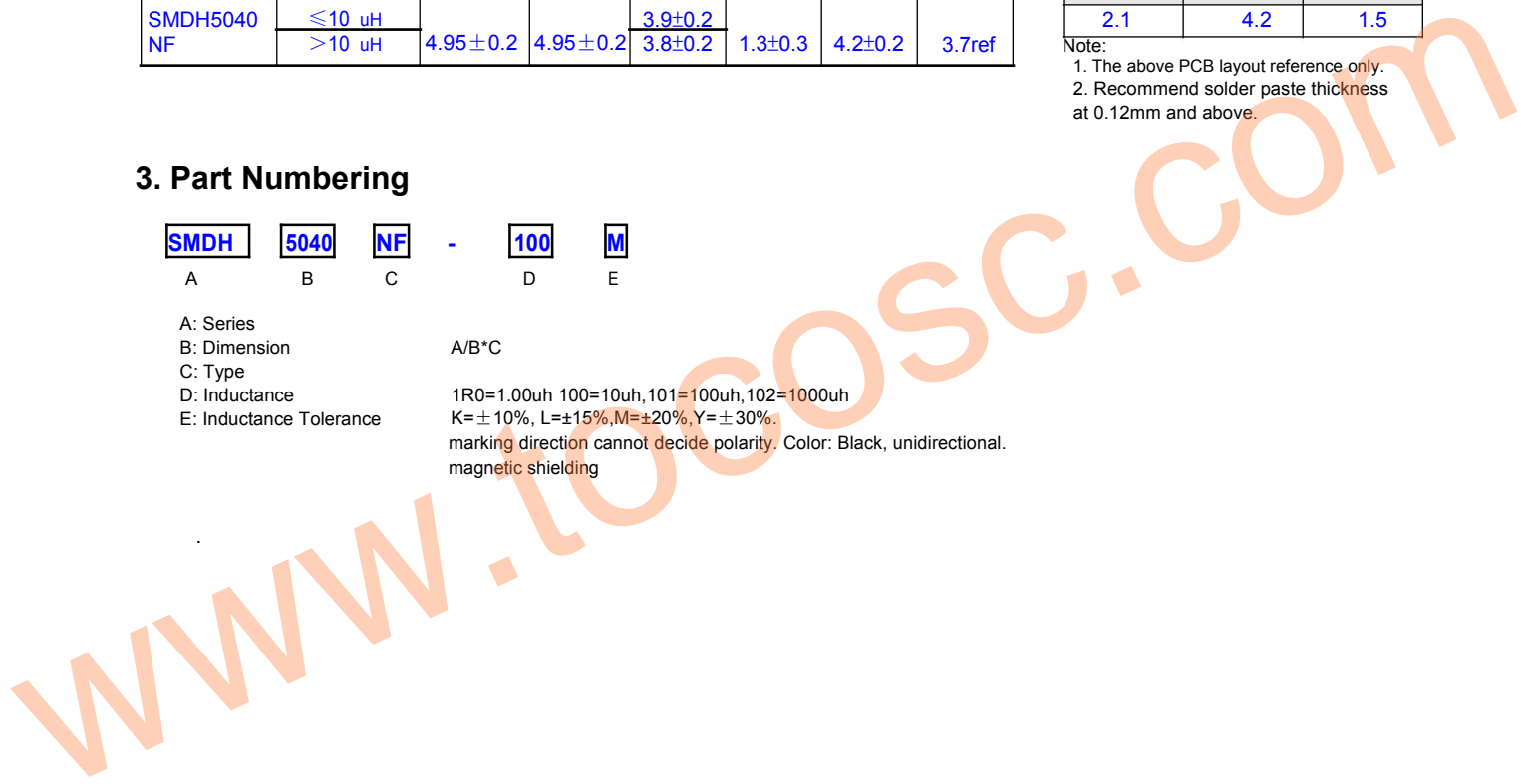



## 4. Specification

Part Number	Inductance L0 (uH) @ 0 A	Tolerance				Rated current		DCR (mΩ) @25°C ±20%.
		K	L	M	Y	Temperature current I rms (A)	Saturation current I sat (A)	
SMDH5040NF-1R0	1.00	/	/	±20%	±30%	5.00	7.50	12
SMDH5040NF-1R5	1.50	/	/	±20%	±30%	4.50	6.50	15
SMDH5040NF-2R2	2.20	/	/	±20%	±30%	3.80	5.70	21
SMDH5040NF-3R3	3.30	/	/	±20%	±30%	3.50	4.40	24
SMDH5040NF-4R7	4.70	/	/	±20%	±30%	3.20	3.90	32
SMDH5040NF-6R8	6.80	/	/	±20%	±30%	2.50	3.30	43
SMDH5040NF-100	10.0	/	/	±20%	±30%	2.20	2.52	56
SMDH5040NF-150	15.0	/	±15%	±20%	±30%	1.80	2.00	80
SMDH5040NF-220	22.0	/	±15%	±20%	±30%	1.50	1.62	123
SMDH5040NF-330	33.0	/	±15%	±20%	±30%	1.20	1.30	180
SMDH5040NF-470	47.0	±10%	±15%	±20%	±30%	1.00	1.10	270
SMDH5040NF-680	68.0	±10%	±15%	±20%	±30%	0.80	0.90	400
SMDH5040NF-101	100	±10%	±15%	±20%	±30%	0.72	0.75	560

Note:

1. All test data referenced to 25°C ambient , Ls:100KHz/1V.
2. Testing Instrument : HP4284A,CH11025,CH3302,CH1320 ,CH1320S LCR METER / Rdc:CH502BC MICRO OHMMETER.
3. Heat Rated Current (Irms) will cause the coil temperature rise approximately 40°C.
4. Saturation Current (Isat) will cause L0 to drop approximately 30%.
5. The part temperature (ambient + temp rise) should not exceed 125°C under worst case operating conditions.Circuit design,component,PCB trace size and thickness,airflow and other cooling provisions all affect the part temperature. Part temperature should be verified in the end application.
6. Special inquiries besides the above common used types can be met on your requirement.

### 5. Typical Performance Curves

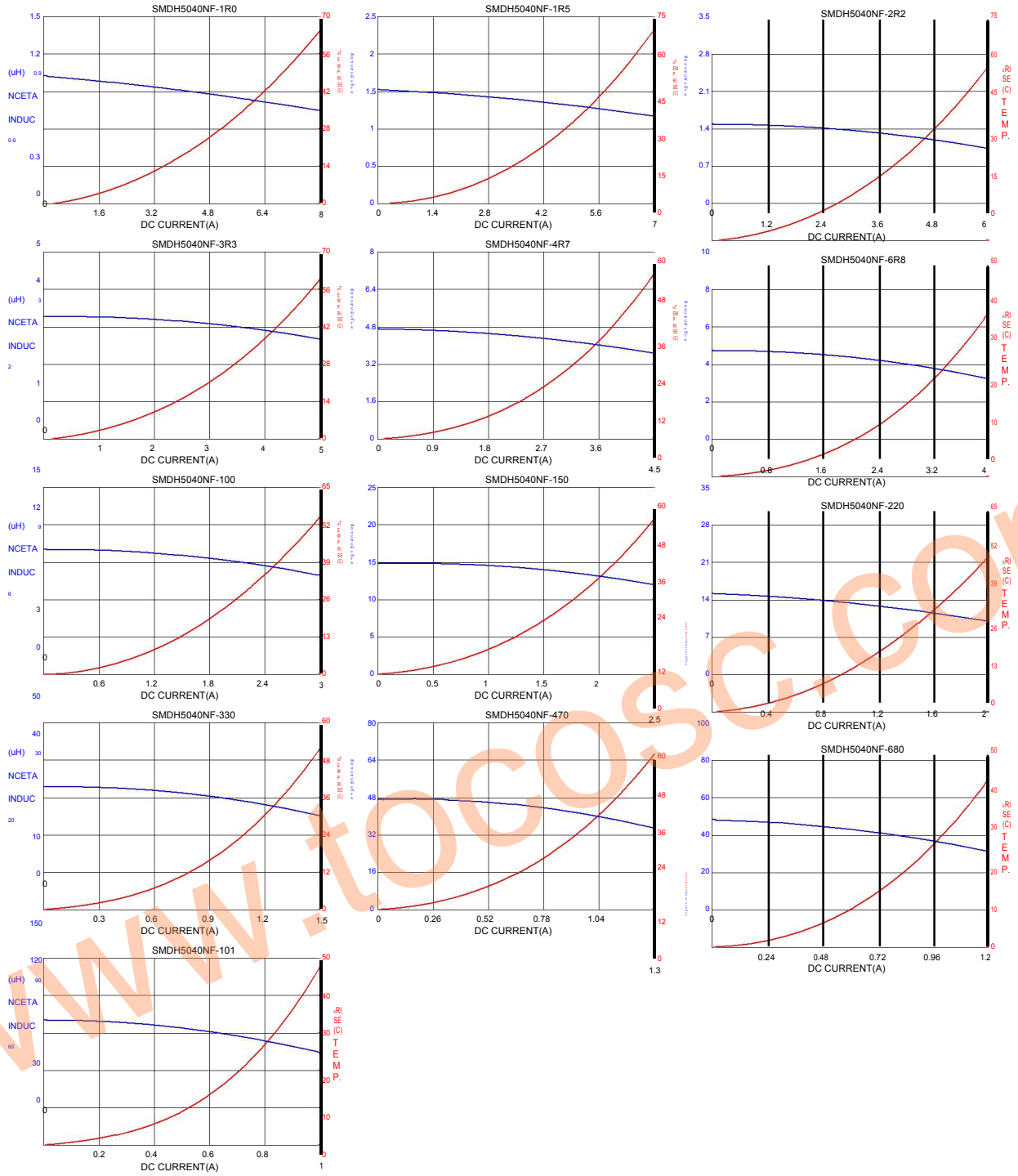

<b>Power Inductor</b>	<b>SMDH6010B-Series</b>
-----------------------	-------------------------

### 1. Features

1. This specification applies Low Profile Power Inductors.
2. 100% Lead(Pb) & Halogen-Free and RoHS compliant.



### 2. Dimension

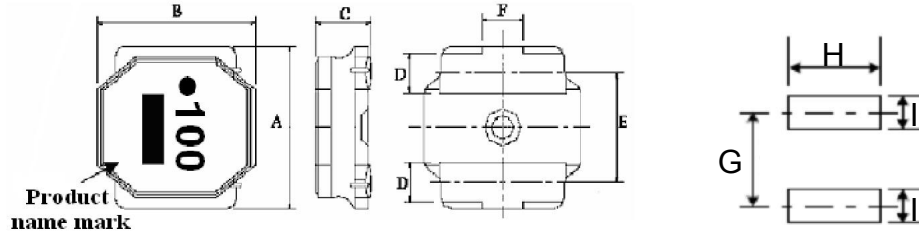

Series	A(mm)	B(mm)	C(mm)	D(mm)	E(mm)	F(mm)	G(mm)	H(mm)	I(mm)
SMDH6010B	6.0±0.2	6.0±0.2	1.0 max.	1.35±0.2	4.0±0.2	2.3 typ.	4.7 ref.	5.7 ref.	1.6 ref.

Units: mm

### 3. Part Numbering

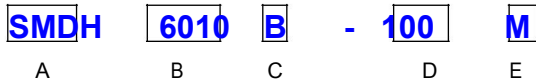

- A: Series
- B: Dimension
- C: Control S/N
- D: Inductance                      100=10.0uH
- E: Inductance Tolerance          M=±20% ; Y=±30%

### 4. Specification

TOCOET Part Number	Inductance (uH)	Tolerance (%)	Test Frequency (Hz)	SRF (MHz) min.	DCR (Ω) ±20%	I sat (A)	I rms (A)
SMDH6010B-1R5M	1.5	±20%	1V100K	77	0.090	2.40	1.90
SMDH6010B-2R2M	2.2	±20%	1V100K	56	0.110	1.90	1.70
SMDH6010B-3R3M	3.3	±20%	1V100K	42	0.135	1.60	1.50
SMDH6010B-4R7M	4.7	±20%	1V100K	36	0.165	1.30	1.40
SMDH6010B-6R8M	6.8	±20%	1V100K	30	0.220	1.20	1.20
SMDH6010B-100M	10	±20%	1V100K	25	0.270	1.00	1.10
SMDH6010B-220M	22	±20%	1V100K	12	0.580	0.65	0.70

Note:

- I<sub>sat</sub> : Based on inductance change (ΔL/L0 : ≤-30%) @ ambient temp. 25°C
- I<sub>rms</sub> : Based on temperature rise (ΔT : 40°C typ.)

SMDH6010B-SERIES

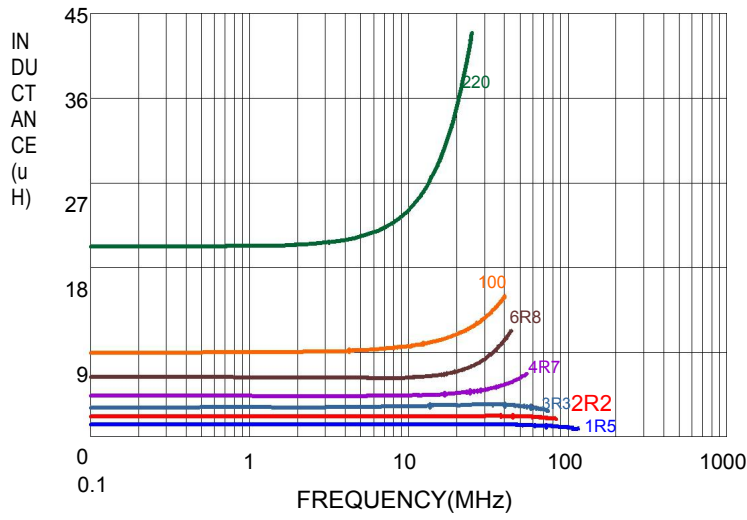

SMDH6010B-SERIES

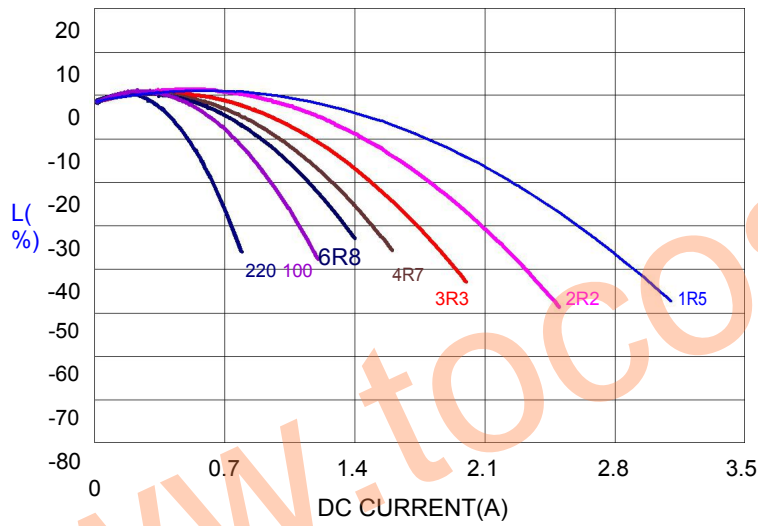

# Power Inductor

**SMDH6012B-  
Series**

## 1. Features

1. This specification applies Low Profile Power Inductors.
2. 100% Lead(Pb) & Halogen-Free and RoHS compliant.

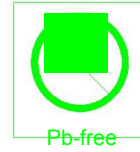

## 2. Dimension

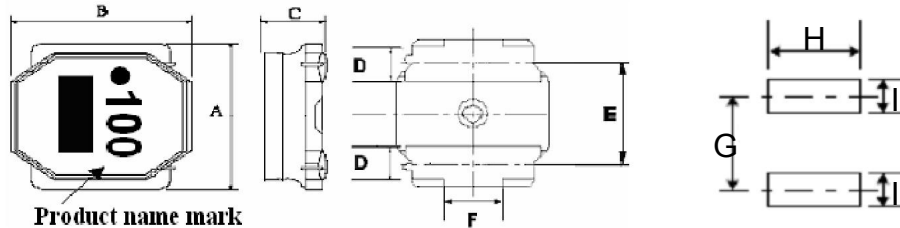

Series	A(mm)	B(mm)	C(mm)	D(mm)	E(mm)	F(mm)	G(mm)	H(mm)	I(mm)
SMDH6012B	6.0±0.2	6.0±0.2	1.2 max.	1.35±0.2	4.0±0.2	2.3 typ.	4.7 ref.	5.7 ref.	1.6 ref.

Units: mm

## 3. Part Numbering

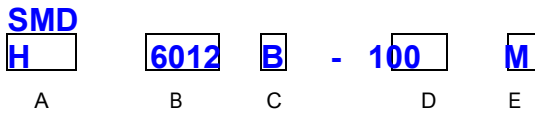

- A: Series
- B: Dimension
- C: Control S/N
- D: Inductance  
100=10.0uH
- E: Inductance Tolerance  
M=±20% ; Y=±30%

## 4. Specification

TOCOET Part Number	Inductance (uH)	Tolerance (%)	Test Frequency (Hz)	SRF (MHz) min.	DCR (Ω) ±20%	I sat (A)	I rms (A)
SMDH6012B-1R0Y	1.0	±30%	1V100K	95	0.050	3.0	2.4
SMDH6012B-1R5Y	1.5	±30%	1V100K	69	0.067	2.6	2.1
SMDH6012B-2R5Y	2.5	±30%	1V100K	45	0.090	2.10	1.80
SMDH6012B-3R3Y	3.3	±30%	1V100K	42	0.105	1.80	1.70
SMDH6012B-4R7M	4.7	±20%	1V100K	36	0.125	1.60	1.55
SMDH6012B-5R3M	5.3	±20%	1V100K	34	0.125	1.50	1.55
SMDH6012B-6R8M	6.8	±20%	1V100K	30	0.165	1.30	1.35
SMDH6012B-100M	10	±20%	1V100K	22	0.200	1.00	1.20
SMDH6012B-150M	15	±20%	1V100K	18	0.295	0.80	0.80
SMDH6012B-220M	22	±20%	1V100K	12	0.465	0.76	0.65
SMDH6012B-330M	33	±20%	1V100K	8	0.580	0.59	0.55
SMDH6012B-470M	47	±20%	1V100K	6	0.965	0.52	0.46
SMDH6012B-680M	68	±20%	1V100K	3	1.160	0.44	0.41
SMDH6012B-101M	100	±20%	1V100K	1	1.670	0.35	0.32

Note:

I<sub>sat</sub> : Based on inductance change (ΔL/L0 : ≤-30%) @ ambient temp. 25°C

I<sub>rms</sub> : Based on temperature rise (ΔT : 40°C typ.)

**Power Inductor** **SMDH6014B-SERIES**

**1. Features**

- 1. This specification applies Low Profile Power Inductors.
- 2. 100% Lead(Pb) & Halogen-Free and RoHS compliant.



**2. Dimension**

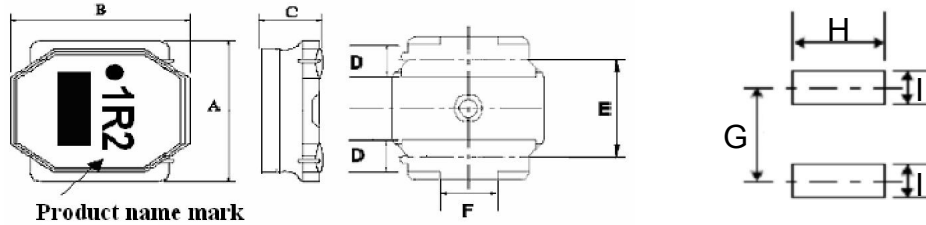

Series	A(mm)	B(mm)	C(mm)	D(mm)	E(mm)	F(mm)	G(mm)	H(mm)	I(mm)
SMDH6014B	6.0±0.2	6.0±0.2	1.4 max.	1.35±0.2	4.0±0.2	2.3 typ.	4.7 ref.	5.7 ref.	1.6 ref.

Units: mm

**3. Part Numbering**

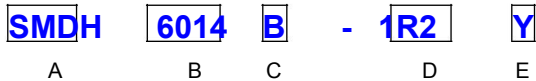

- A: Series
- B: Dimension
- C: Control S/N
- D: Inductance                      1R2=1.2uH
- E: Inductance Tolerance            M=±20% ; Y=±30%

**4. Specification**

TOCOET Part Number	Inductance (uH)	Tolerance (%)	Test Frequency (Hz)	SRF (MHz) min.	DCR (Ω) ±20%	I sat (A)	I rms (A)
SMDH6014B-1R2Y	1.2	±30%	1V100K	77	0.042	4.10	2.75
SMDH6014B-2R2Y	2.2	±30%	1V100K	61	0.055	3.00	2.30
SMDH6014B-3R3Y	3.3	±30%	1V100K	41	0.075	2.50	2.00
SMDH6014B-4R7M	4.7	±20%	1V100K	36	0.090	2.00	1.90
SMDH6014B-6R8M	6.8	±20%	1V100K	30	0.115	1.70	1.65
SMDH6014B-100M	10	±20%	1V100K	24	0.140	1.40	1.40
SMDH6014B-150M	15	±20%	1V100K	20	0.210	1.15	1.20
SMDH6014B-220M	22	±20%	1V100K	16	0.300	0.95	1.00

Note:

- Isat : Based on inductance change ( ΔL/L0 : ≤-30% ) @ ambient temp. 25°C
- Irms : Based on temperature rise ( ΔT : 40°C typ. )

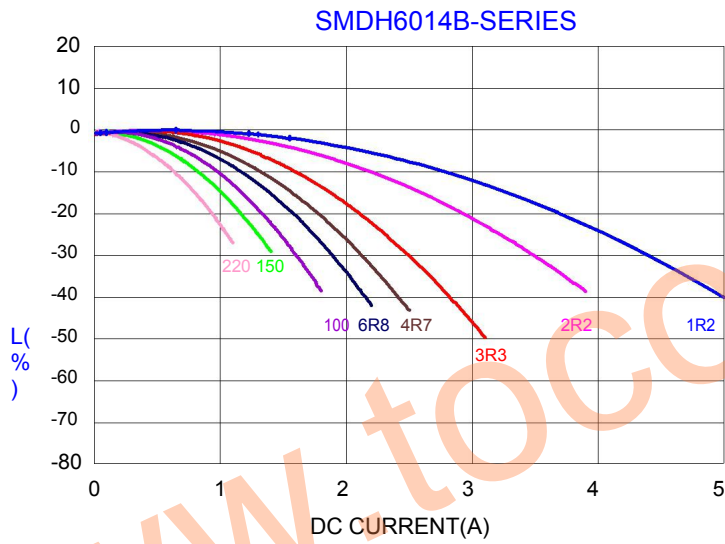
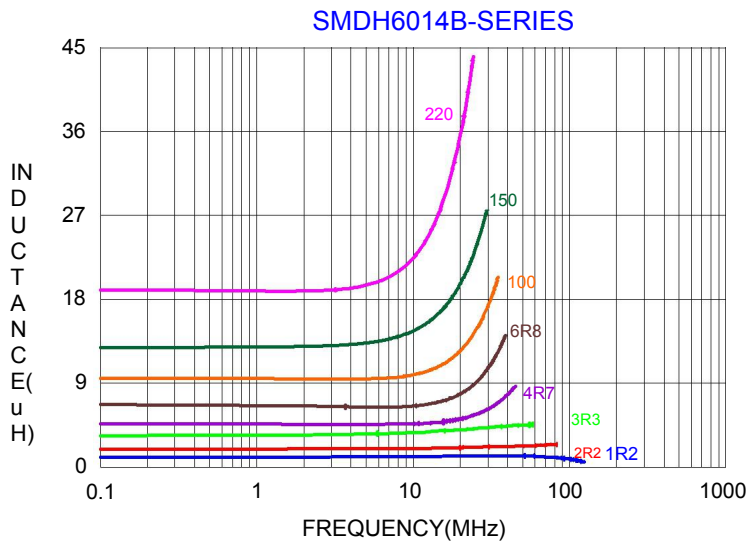

www.tocosc.com

<b>SMD Power Inductor</b>	<b>SMDH6020NF-Series</b>
---------------------------	--------------------------

**1. Features**

1. This specification applies Low Profile Power Inductors.
2. 100% Lead(Pb) & Halogen-Free and RoHS compliant.



**2. Dimension**

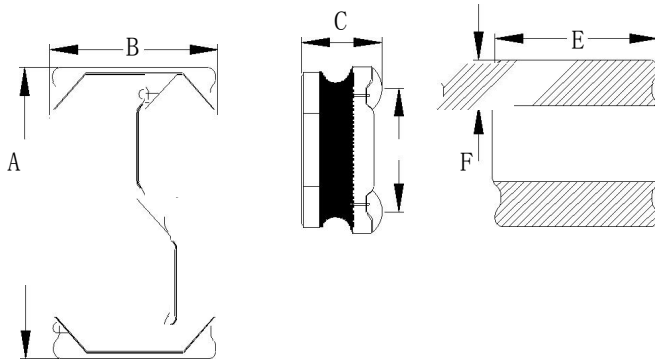

Series	*A(mm)	*B(mm)	*C(mm)	D(mm)	E(mm)	F(mm)
SMDH6020NF	6.0±0.2	6.0±0.2	1.8±0.2	1.6±0.3	5.8±0.3	4.3ref

\*Dimensions are not including the termination. For maximum overall dimensions with termination, add 0.1mm.

**Recommended Land pattern**

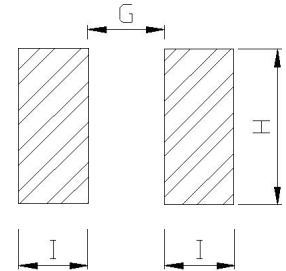

G(mm)	H(mm)	I(mm)
2.5	5.8	1.8

Note: 1. The above PCB layout reference only.  
 2. Recommend solder paste thickness at 0.15mm and above.

**3. Part Numbering**



- A: Series
- B: Dimension
- C: Type
- D: Inductance
- E: Inductance Tolerance

A/B\*C

1R0=1.00uh 100=10uh,101=100uh,102=1000uh  
 K=± 10%, L=±15%,M=±20%,Y=± 30%.

marking direction cannot decide polarity. Color: Black, unidirectional.  
 magnetic shielding

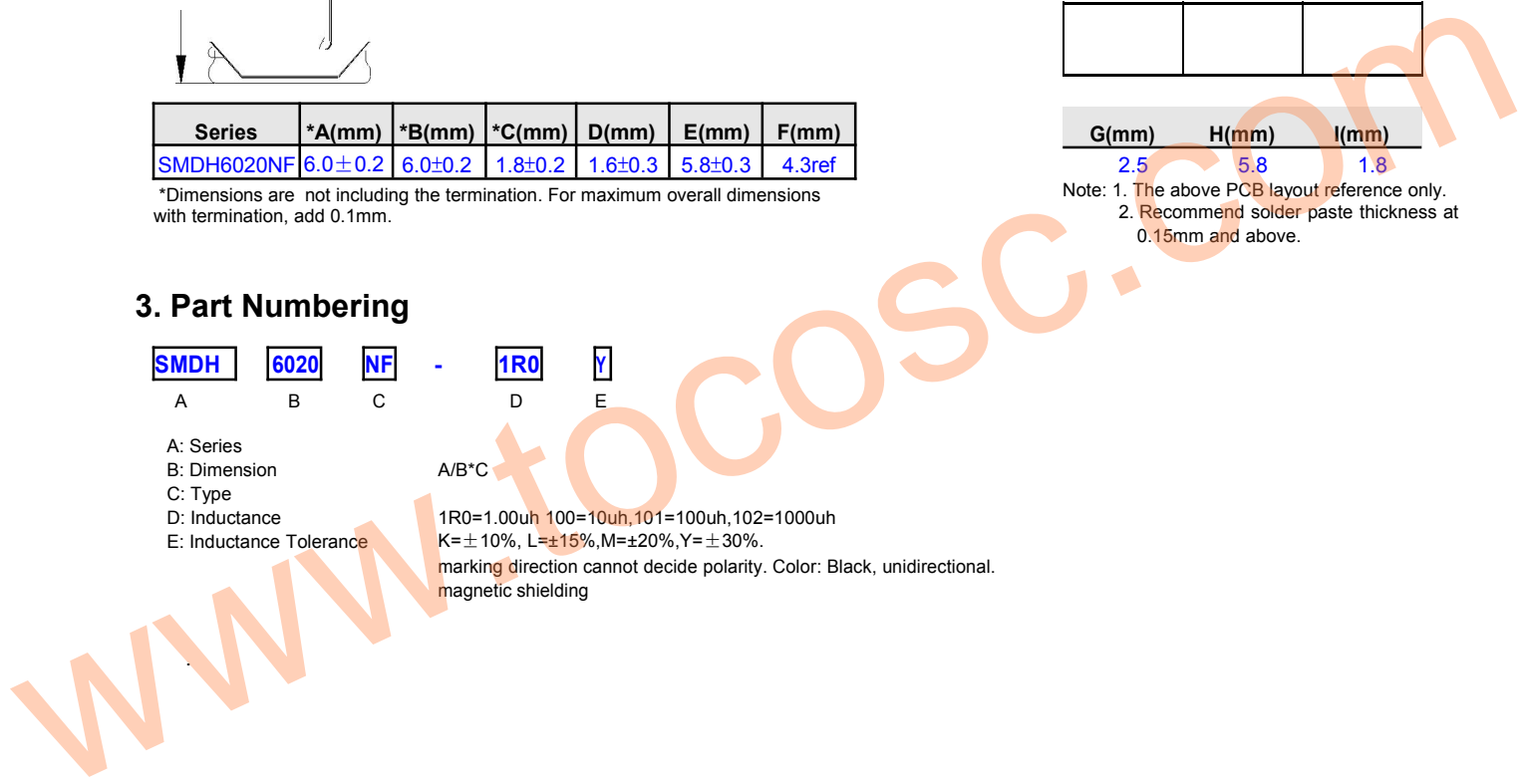



## 4. Specification

Part Number	Inductance L0 (uH) @ 0 A	Tolerance				Rated current		DCR (mΩ)@25°C ±20%.
						Temperature current I rms (A)	Saturation current I sat (A)	
		K	L	M	Y			
SMDH6020NF-1R0	1.00	/	/	±20%	±30%	4.5	6.2	19
SMDH6020NF-1R5	1.50	/	/	±20%	±30%	3.8	5.5	22.5
SMDH6020NF-2R0	2.00	/	/	±20%	±30%	3.65	5.3	25
SMDH6020NF-2R2	2.20	/	/	±20%	±30%	3.5	5	29
SMDH6020NF-3R3	3.30	/	/	±20%	±30%	3.3	4	35
SMDH6020NF-4R7	4.70	/	±15%	±20%	±30%	2.8	3	54
SMDH6020NF-5R6	5.60	/	±15%	±20%	±30%	2.6	2.7	59
SMDH6020NF-6R8	6.80	/	±15%	±20%	±30%	2.5	2.6	78
SMDH6020NF-8R2	8.20	/	±15%	±20%	±30%	2.3	2.4	103
SMDH6020NF-100	10.0	±10%	±15%	±20%	±30%	2.1	2.1	106
SMDH6020NF-150	15.0	±10%	±15%	±20%	±30%	1.6	1.5	138
SMDH6020NF-220	22.0	±10%	±15%	±20%	±30%	1.4	1.3	204

Note:

1. All test data referenced to 25°C ambient , Ls:100KHz/1V.
2. Testing Instrument : HP4284A,CH11025,CH3302,CH1320 ,CH1320S LCR METER / Rdc:CH502BC MICRO OHMMETER.
3. Heat Rated Current (I rms) will cause the coil temperature rise approximately t of 40°C
4. Saturation Current (Isat) will cause L0 to drop approximately 30%
5. The part temperature (ambient + temp rise) should not exceed 125°C under worst case operating conditions. Circuit design, component, PCB trace size and thickness, airflow and other cooling provisions all affect the part temperature. Part temperature should be verified in the end application.
6. Special inquiries besides the above common used types can be met on your requirement.

### 5. Typical Performance Curves

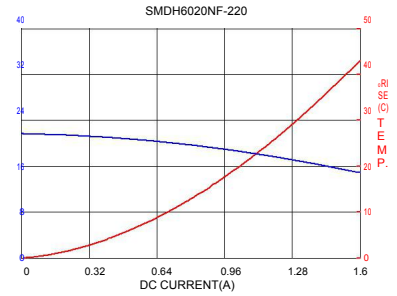
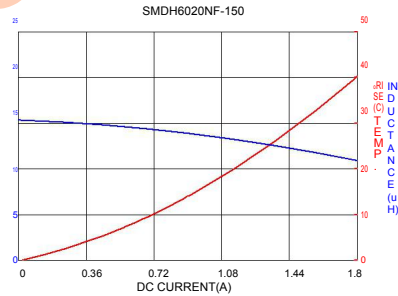
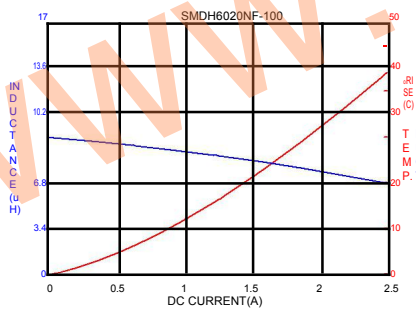
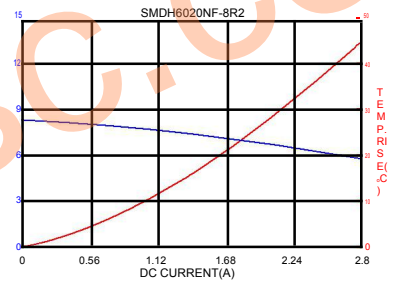
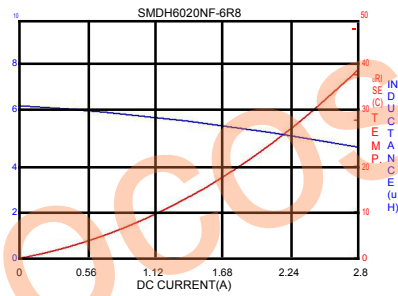
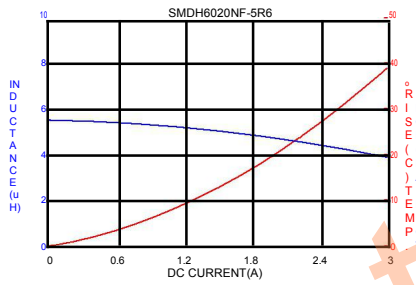
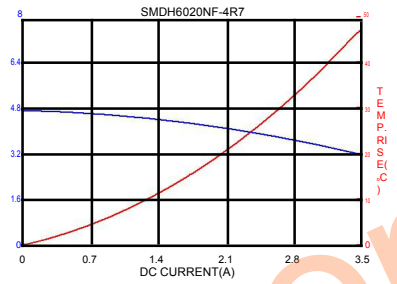
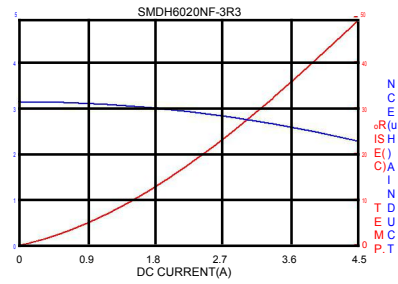
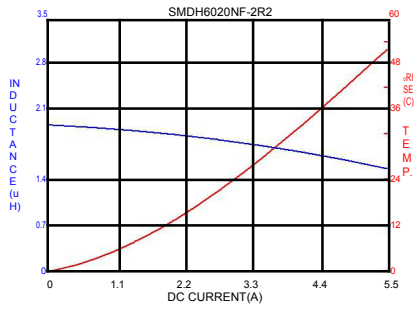
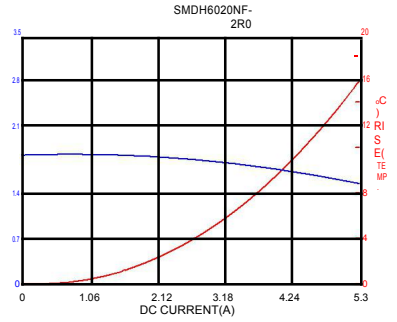
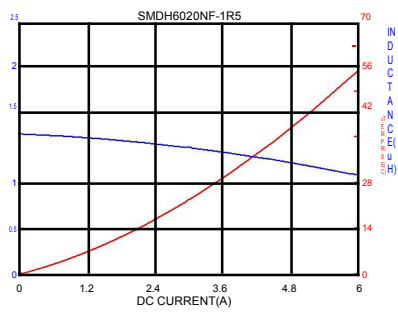
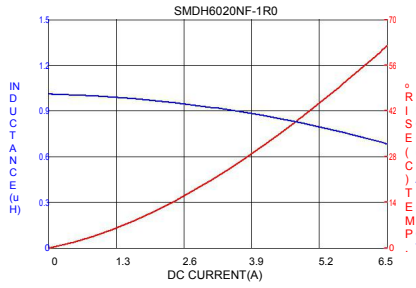

<b>SMD Power Inductor</b>	<b>SMDH6028NF-Series</b>
---------------------------	--------------------------

### 1. Features

1. This specification applies Low Profile Power Inductors.
2. 100% Lead(Pb) & Halogen-Free and RoHS compliant.



### 2. Dimension

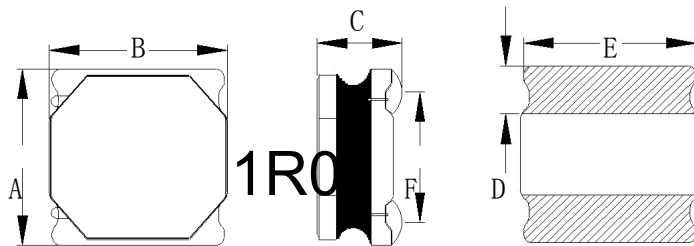

Series	*A(mm)	*B(mm)	*C(mm)	D(mm)	E(mm)	F(mm)
SMDH6028NF	6.0±0.2	6.0±0.2	2.6±0.2	1.6±0.3	5.8±0.3	4.3ref

\*Dimensions are not including the termination. For maximum overall dimensions with termination, add 0.1mm.

### Recommended Land pattern

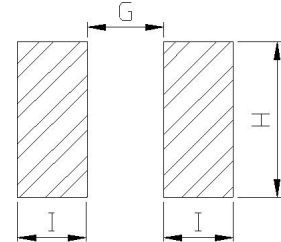

G(mm)	H(mm)	I(mm)
2.5	5.8	1.8

Note: 1. The above PCB layout reference only.  
 2. Recommend solder paste thickness at 0.15mm and above.

### 3. Part Numbering

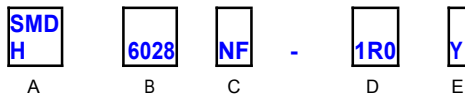

- A: Series
- B: Dimension
- C: Type
- D: Inductance
- E: Inductance Tolerance

A/B\*C

1R0=1.00uh 100=10uh, 101=100uh, 102=1000uh  
 K=±10%, L=±15%, M=±20%, Y=±30%.

marking direction cannot decide polarity. Color: Black, unidirectional magnetic shielding

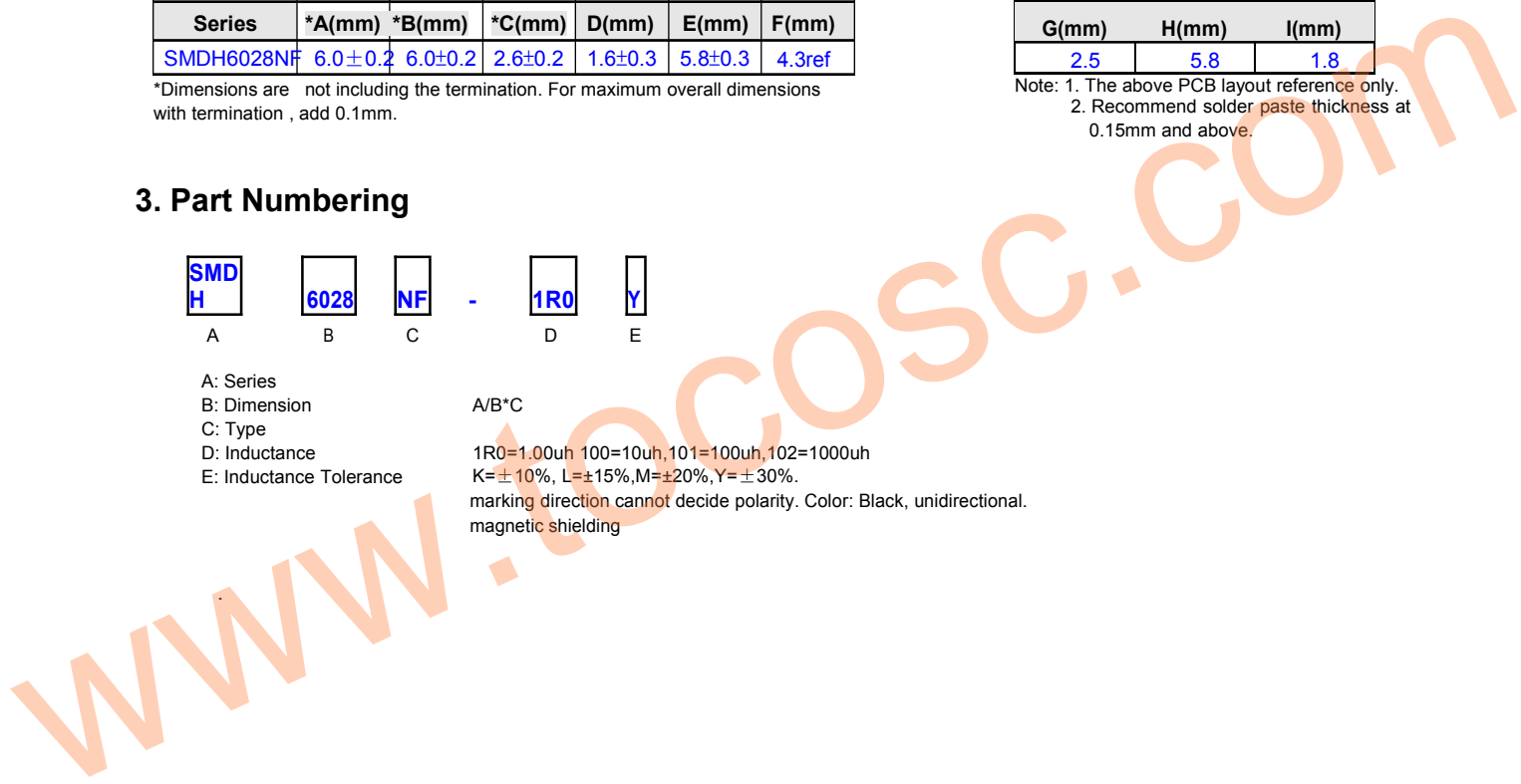

## 4. Specification

Part Number	Inductance L0 (uH) @ 0 A	Tolerance	Rated current		DCR (mΩ) @25°C ±20%.
			Temperature current I rms (A)	Saturation current I sat (A)	
SMDH6028NF-1R0Y	1.00	±30%	5.20	5.75	10.0
SMDH6028NF-1R5Y	1.50	±30%	4.95	5.30	14.0
SMDH6028NF-2R2M	2.20	±20%	4.50	5.00	18.0
SMDH6028NF-3R3M	3.30	±20%	3.60	4.30	24.0
SMDH6028NF-4R7M	4.70	±20%	3.10	3.20	30.0
SMDH6028NF-6R8M	6.80	±20%	2.50	2.85	47.0
SMDH6028NF-100M	10.0	±20%	2.00	2.10	65.0
SMDH6028NF-150M	15.0	±20%	1.80	2.00	98.0
SMDH6028NF-220M	22.0	±20%	1.50	1.60	138
SMDH6028NF-330M	33.0	±20%	1.30	1.40	200
SMDH6028NF-470M	47.0	±20%	1.06	1.15	280
SMDH6028NF-680M	68.0	±20%	0.81	1.00	420
SMDH6028NF-101M	100	±20%	0.72	0.80	605

Note:

1. All test data referenced to 25°C ambient , Ls:100KHz/1V.
2. Testing Instrument : HP4284A,CH11025,CH3302,CH1320 ,CH1320S LCR METER / Rdc:CH502BC MICRO OHMMETER.
3. Heat Rated Current (I rms) will cause the coil temperature rise approximately 1 of 40°C
4. Saturation Current (Isat) will cause L0 to drop approximately 30%
5. The part temperature (ambient + temp rise) should not exceed 125°C under worst case operating conditions.Circuit design,component,PCB trace size and thickness,airflow and other cooling provisions all affect the part temperature. Part temperature should be verified in the end application.
6. Special inquiries besides the above common used types can be met on your requirement.

### 5. Typical Performance Curves

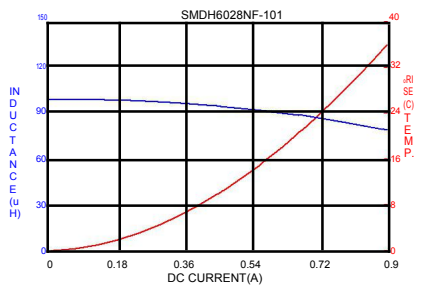
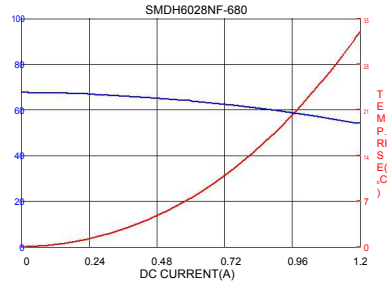
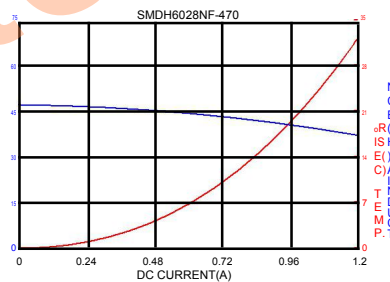
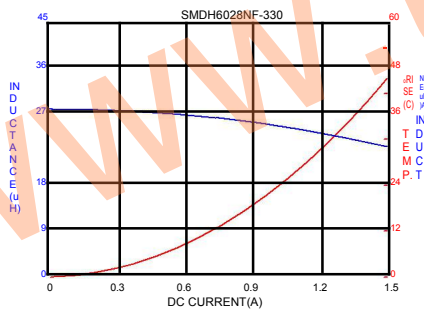
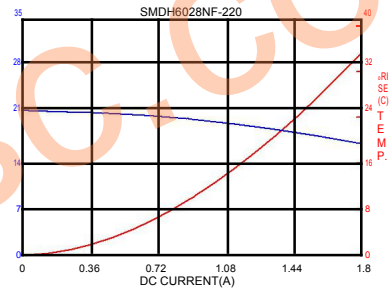
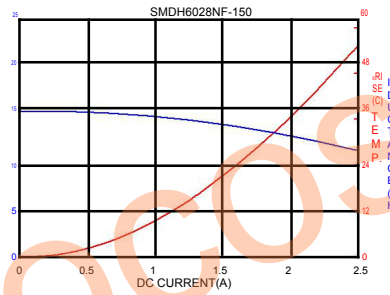
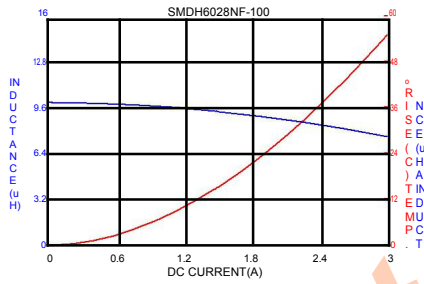
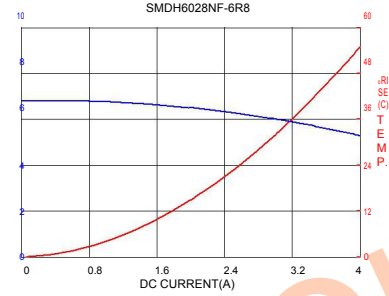
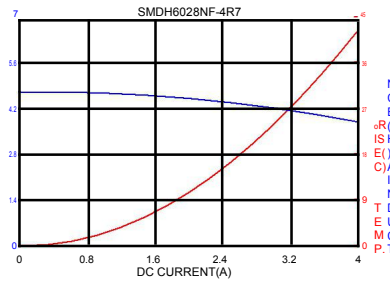
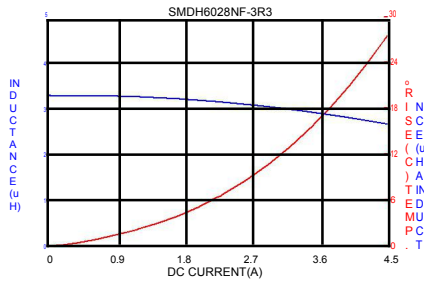
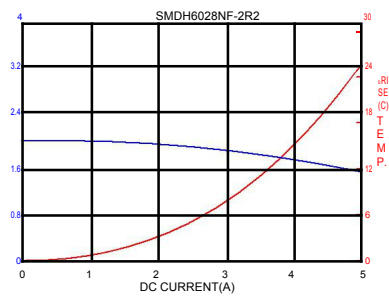
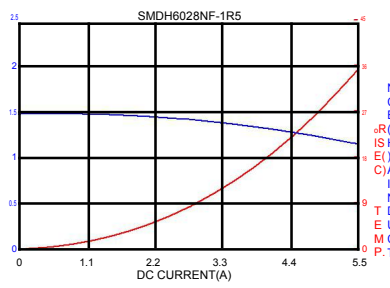
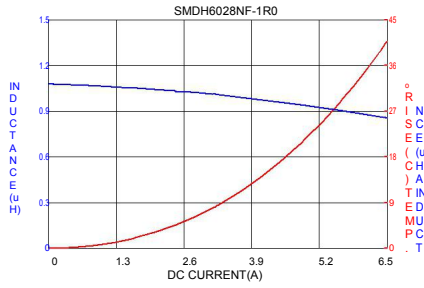

**SMD Power Inductor**

**SMDH6045NF-Series**

**1. Features**

- 1. This specification applies Low Profile Power Inductors.
- 2. 100% Lead(Pb) & Halogen-Free and RoHS compliant.



**2. Dimension**

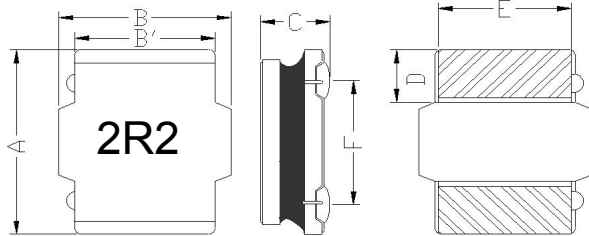

**Recommended Land pattern**

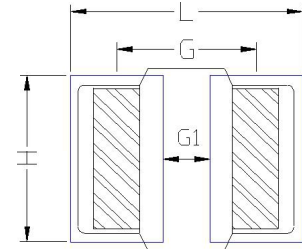

Series	A(mm)	B(mm)	B'(mm)	C(mm)	D(mm)	E(mm)	F(mm)
SMDH6045NF	6.0±0.3	6.0±0.3	4.8±0.2	4.2±0.3	1.7±0.3	4.5±0.3	4.25±0.3

L(mm)	G(mm)	G1(mm)	H(mm)
6.5	4.25	1.80min	4.8

Note: 1. The above PCB layout reference only.  
 2. Recommend solder paste thickness at 0.15mm and above.

**3. Part Numbering**



A: Series  
 B: Dimension  
 C: Type  
 D: Inductance  
 E: Inductance Tolerance

A/B\*C

2R2=2.20uh 100=10uh, 101=100uh, 102=1000uh  
 M=±20%, Y=±30%.

marking direction cannot decide polarity. Color: Black, unidirectional.  
 magnetic shielding

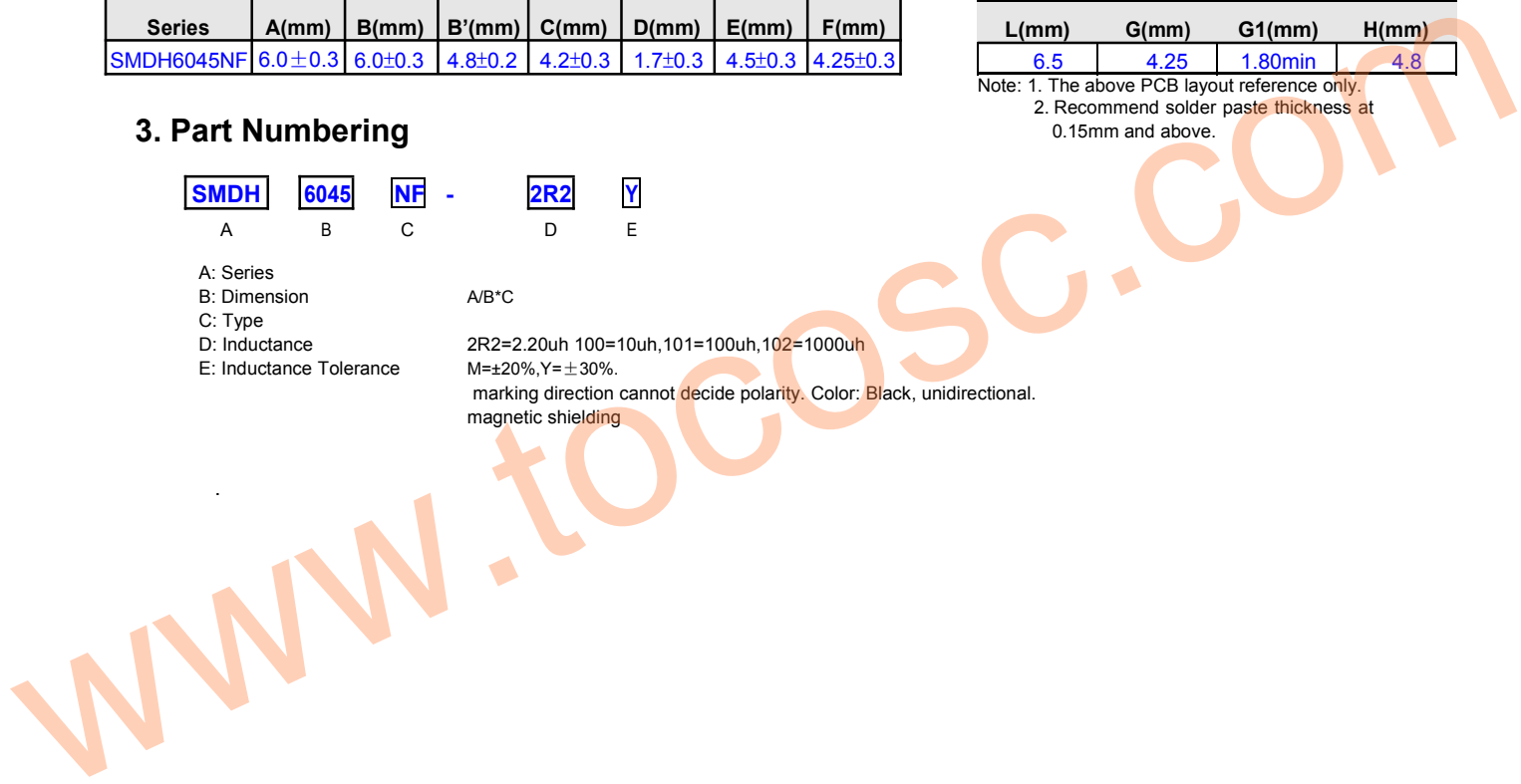

### 4. Specification

Part Number	Inductance L0 (uH) @ 0 A	Tolerance				Rated current				DCR (mΩ) @25°C ±20%.
						Temperature current I rms (A)		Saturation current I sat (A)		
		K	L	M	Y	Typ	Max	Typ	Max	
SMDH6045NF-R36	0.36	/	/	±20%	±30%	9.00	8.50	18.00	16.50	4.80
SMDH6045NF-R47	0.47	/	/	±20%	±30%	8.60	8.00	17.00	16.00	6.80
SMDH6045NF-R82	0.82	/	/	±20%	±30%	8.20	7.50	14.50	13.50	8.50
SMDH6045NF-1R0	1.00	/	/	±20%	±30%	8.00	7.30	13.50	12.50	10.0
SMDH6045NF-1R2	1.20	/	/	±20%	±30%	7.50	7.00	12.50	11.50	10.5
SMDH6045NF-1R3	1.30	/	/	±20%	±30%	7.50	7.00	12.50	11.50	10.5
SMDH6045NF-1R5	1.50	/	/	±20%	±30%	7.00	6.60	12.00	11.00	11.7
SMDH6045NF-1R8	1.80	/	/	±20%	±30%	6.80	6.20	11.00	10.00	12.0
SMDH6045NF-2R0	2.00	/	/	±20%	±30%	6.50	5.80	10.50	9.50	13.5
SMDH6045NF-2R2	2.20	/	/	±20%	±30%	6.00	5.30	9.50	8.55	15.0
SMDH6045NF-2R3	2.30	/	/	±20%	±30%	5.80	5.00	9.30	8.20	16.0
SMDH6045NF-3R0	3.00	/	/	±20%	±30%	5.20	4.60	8.00	7.50	20.0
SMDH6045NF-3R3	3.30	/	/	±20%	±30%	5.00	4.50	7.80	7.30	21.0
SMDH6045NF-3R6	3.60	/	/	±20%	±30%	4.90	4.30	7.40	6.90	22.5
SMDH6045NF-4R7	4.70	/	±15%	±20%	±30%	4.50	4.00	6.80	6.20	26.0
SMDH6045NF-5R6	5.60	/	±15%	±20%	±30%	4.10	3.70	6.40	5.70	31.0
SMDH6045NF-6R3	6.30	/	±15%	±20%	±30%	3.80	3.50	5.90	5.30	33.0
SMDH6045NF-6R8	6.80	/	±15%	±20%	±30%	3.60	3.30	5.70	5.15	34.0
SMDH6045NF-8R2	8.20	/	±15%	±20%	±30%	3.40	2.90	5.10	4.50	46.0
SMDH6045NF-100	10.0	±10%	±15%	±20%	±30%	3.20	2.60	4.60	4.20	52.0
SMDH6045NF-150	15.0	±10%	±15%	±20%	±30%	2.80	2.20	3.80	3.30	71.0
SMDH6045NF-180	18.0	±10%	±15%	±20%	±30%	2.60	2.10	3.40	2.90	80.0
SMDH6045NF-220	22.0	±10%	±15%	±20%	±30%	2.30	1.90	3.30	2.70	96.0
SMDH6045NF-330	33.0	±10%	±15%	±20%	±30%	1.80	1.50	2.50	2.10	145
SMDH6045NF-470	47.0	±10%	±15%	±20%	±30%	1.60	1.20	2.00	1.75	200
SMDH6045NF-560	56.0	±10%	±15%	±20%	±30%	1.40	1.00	1.80	1.65	230
SMDH6045NF-680	68.0	±10%	±15%	±20%	±30%	1.10	0.92	1.60	1.52	305
SMDH6045NF-820	82.0	±10%	±15%	±20%	±30%	0.98	0.88	1.50	1.40	365
SMDH6045NF-101	100	±10%	±15%	±20%	±30%	0.92	0.82	1.33	1.25	456
SMDH6045NF-121	120	±10%	±15%	±20%	±30%	0.85	0.79	1.20	1.10	500
SMDH6045NF-151	150	±10%	±15%	±20%	±30%	0.75	0.70	1.10	1.00	626
SMDH6045NF-181	180	±10%	±15%	±20%	±30%	0.68	0.60	1.00	0.90	745
SMDH6045NF-221	220	±10%	±15%	±20%	±30%	0.60	0.50	0.88	0.77	900
SMDH6045NF-331	330	±10%	±15%	±20%	±30%	0.55	0.45	0.60	0.55	1400
SMDH6045NF-471	470	±10%	±15%	±20%	±30%	0.40	0.35	0.50	0.45	2050

Note:

1. All test data referenced to 25°C ambient , Ls/Q:1MHz/1V.
2. Testing Instrument : HP4284A,CH11025,CH3302,CH1320 ,CH1320S LCR METER / Rdc:CH502BC MICRO OHMMETER.
3. Heat Rated Current (I rms) will cause the coil temperature rise approximately t of 40°C
4. Saturation Current (Isat) will cause L0 to drop approximately 30%
5. The part temperature (ambient + temp rise) should not exceed 125°C under worst case operating conditions.Circuit design,component,PCB trace size and thickness,airflow and other cooling provisions all affect the part temperature. Part temperature should be verified in the end application.
6. Special inquiries besides the above common used types can be met on your requirement.

### 5. Typical Performance Curves

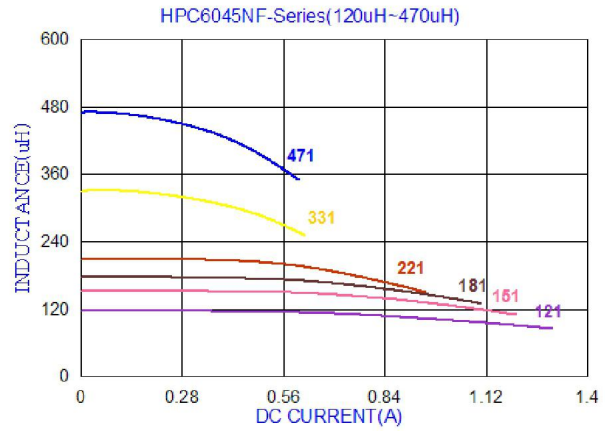
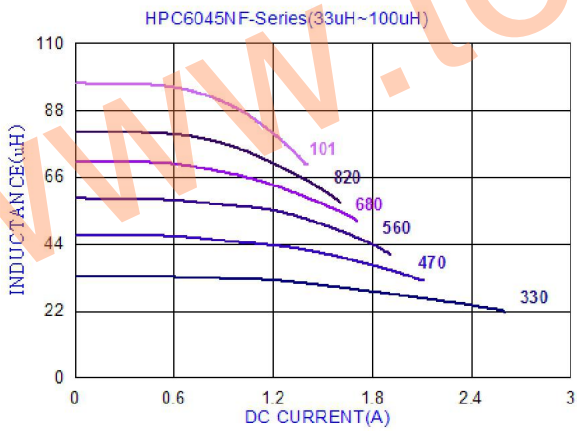
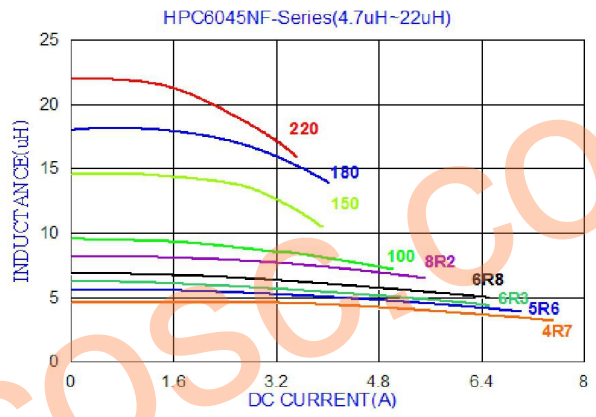
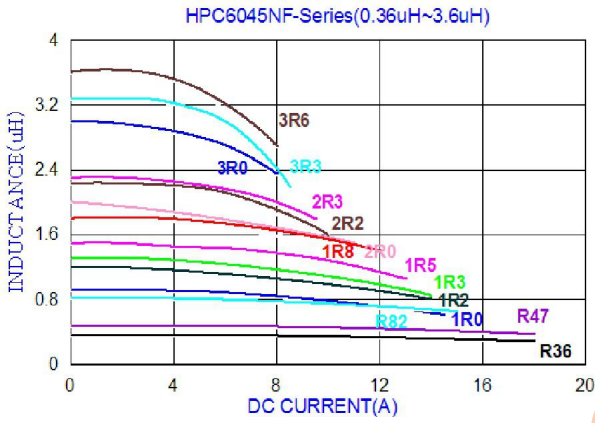
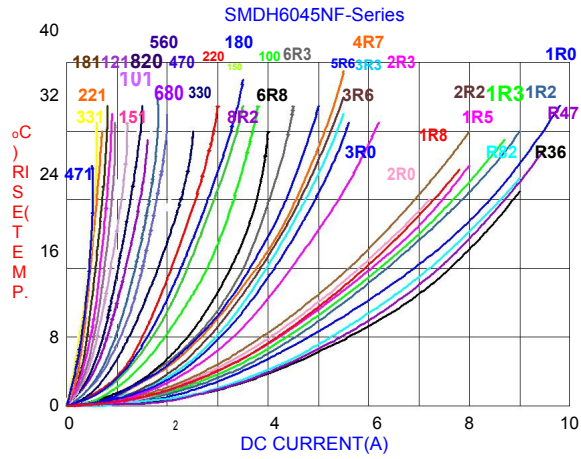



<b>SMD Power Inductor</b>	<b>SMDH8040NF-Series-Z01</b>
---------------------------	------------------------------

**1. Features**

1. This specification applies Low Profile Power Inductors.
2. 100% Lead(Pb) & Halogen-Free and RoHS compliant.



**2. Dimension**

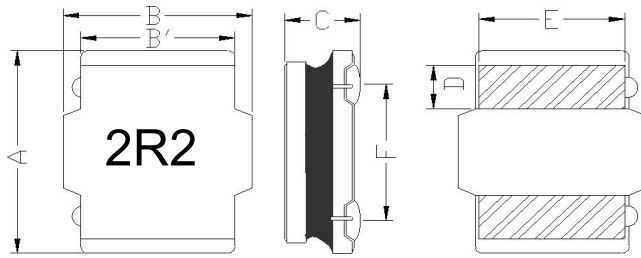

**Recommended Land pattern**

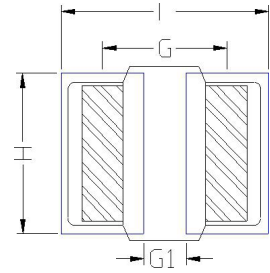

Series	Inductance	A(mm)	B(mm)	B'(mm)	C(mm)	D(mm)	E(mm)	F(mm)
SMDH8040NF	≤10 uH	8.0±0.3	8.0±0.3	6.3±0.2	3.9±0.3	2.0±0.3	6.0±0.3	5.5±0.3
	>10 uH				3.7±0.3			

L(mm)	G(mm)	H(mm)	G1(mm)
8.5	5.5	6.3	2.5

Note: 1. The above PCB layout reference only.  
 2. Recommend solder paste thickness at 0.15mm and above.

**3. Part Numbering**



A: Series  
 B: Dimension  
 C: Type  
 D: Inductance  
 E: Inductance Tolerance  
 F: Code

A/B°C  
 2R2=2.20uh 100=10uh,101=100uh,102=1000uh  
 K=±10%,M=±20%,Y=±30%.  
 marking direction cannot decide polarity. Color: Black, unidirectional magnetic shielding

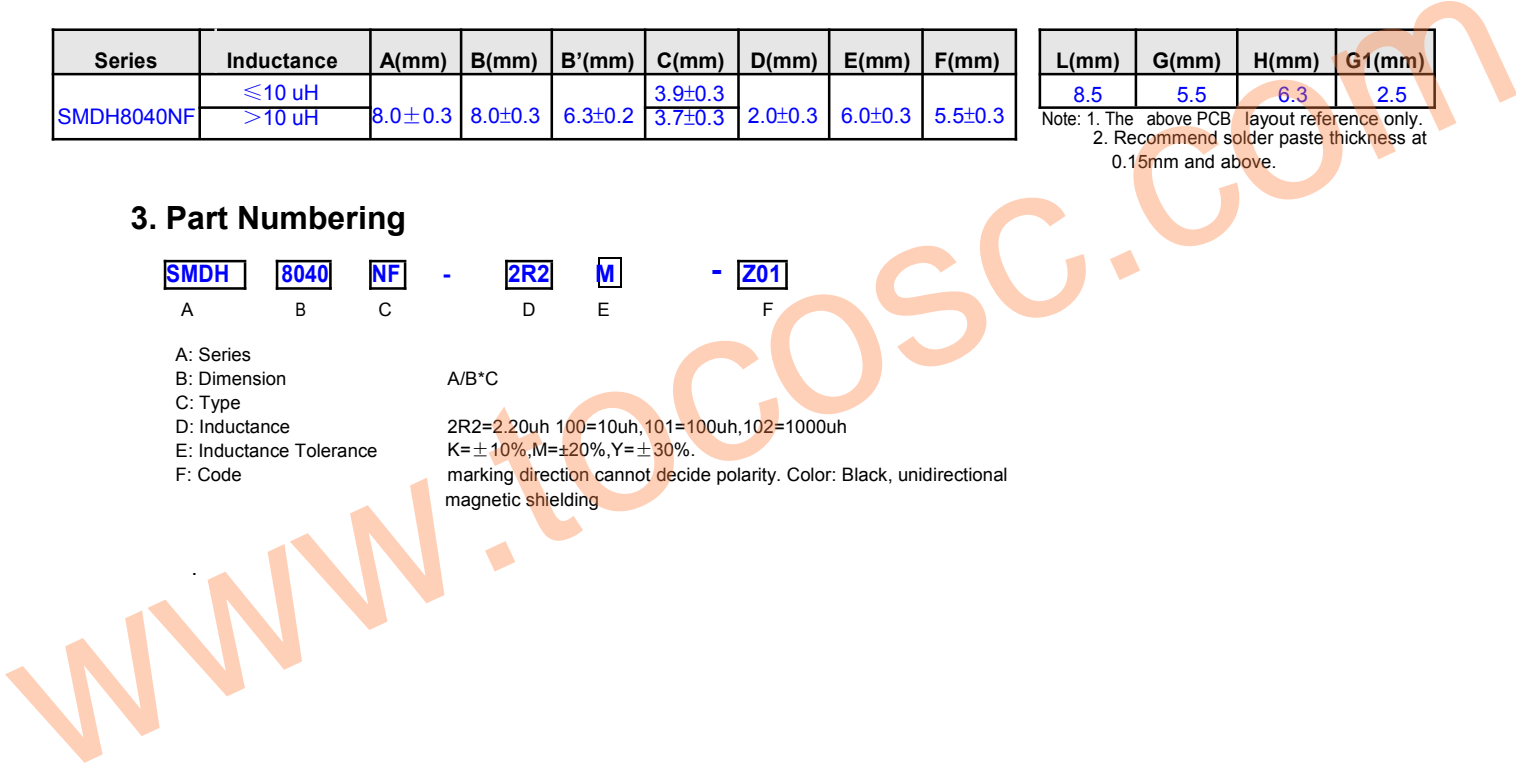

### 4. Specification

Part Number	Inductance L0 (uH) @ 0 A	Tolerance				Frequency	Rated current				DCR (mΩ) @25°C ±20%
		K	L	M	Y		Temperature current I rms (A)		Saturation current I sat (A)		
							Typ	Max	Typ	Max	
SMDH8040NF-1R0□-Z01	1.00	/	/	±20%	±30%	1MHz/1V	8.50	8.00	13.80	13.00	8.2
SMDH8040NF-1R2□-Z01	1.20	/	/	±20%	±30%	1MHz/1V	8.30	7.80	12.80	11.50	8.2
SMDH8040NF-1R4□-Z01	1.40	/	/	±20%	±30%	1MHz/1V	8.20	7.80	11.80	11.20	10.0
SMDH8040NF-1R5□-Z01	1.50	/	/	±20%	±30%	1MHz/1V	8.00	7.70	11.50	11.00	10.0
SMDH8040NF-1R6□-Z01	1.60	/	/	±20%	±30%	1MHz/1V	8.00	7.70	11.50	11.00	10.0
SMDH8040NF-2R0□-Z01	2.0	/	/	±20%	±30%	1MHz/1V	7.50	7.10	10.20	9.60	11.0
SMDH8040NF-2R2□-Z01	2.20	/	/	±20%	±30%	1MHz/1V	7.40	6.90	9.80	9.20	11.5
SMDH8040NF-2R7□-Z01	2.70	/	/	±20%	±30%	1MHz/1V	7.00	6.50	9.00	8.20	13.0
SMDH8040NF-3R3□-Z01	3.30	/	/	±20%	±30%	1MHz/1V	6.60	6.20	8.00	7.50	15.0
SMDH8040NF-4R7□-Z01	4.70	/	±15%	±20%	±30%	1MHz/1V	5.80	5.30	6.70	6.00	19.5
SMDH8040NF-5R6□-Z01	5.60	/	±15%	±20%	±30%	1MHz/1V	5.40	5.20	6.20	5.80	22.0
SMDH8040NF-6R8□-Z01	6.80	/	±15%	±20%	±30%	1MHz/1V	5.10	5.00	5.60	5.10	25.0
SMDH8040NF-8R2□-Z01	8.20	/	±15%	±20%	±30%	1MHz/1V	4.80	4.50	5.30	4.60	30.0
SMDH8040NF-100□-Z01	10.0	±10%	±15%	±20%	±30%	1MHz/1V	4.60	4.20	5.00	4.30	33.0
SMDH8040NF-150□-Z01	15.0	±10%	±15%	±20%	±30%	1MHz/1V	3.60	3.20	4.00	3.60	50.0
SMDH8040NF-220□-Z01	22.0	±10%	±15%	±20%	±30%	1MHz/1V	2.90	2.45	3.10	2.80	73.0
SMDH8040NF-330□-Z01	33.0	±10%	±15%	±20%	±30%	1MHz/1V	2.30	2.10	2.60	2.10	100
SMDH8040NF-470□-Z01	47.0	±10%	±15%	±20%	±30%	1MHz/1V	2.00	1.70	2.20	1.90	135
SMDH8040NF-560□-Z01	56.0	±10%	±15%	±20%	±30%	1MHz/1V	1.75	1.60	1.90	1.60	160
SMDH8040NF-680□-Z01	68.0	±10%	±15%	±20%	±30%	1MHz/1V	1.65	1.50	1.75	1.50	205
SMDH8040NF-820□-Z01	82.0	±10%	±15%	±20%	±30%	1MHz/1V	1.40	1.30	1.60	1.40	230
SMDH8040NF-101□-Z01	100	±10%	±15%	±20%	±30%	1MHz/1V	1.20	1.10	1.45	1.20	300
SMDH8040NF-121□-Z01	120	±10%	±15%	±20%	±30%	1MHz/1V	1.10	1.00	1.30	1.10	350
SMDH8040NF-151□-Z01	150	±10%	±15%	±20%	±30%	1MHz/1V	0.98	0.90	1.20	1.03	410
SMDH8040NF-181□-Z01	180	±10%	±15%	±20%	±30%	1MHz/1V	0.91	0.83	1.04	0.94	490
SMDH8040NF-221□-Z01	220	±10%	±15%	±20%	±30%	1MHz/1V	0.85	0.76	0.99	0.90	610
SMDH8040NF-331□-Z01	330	±10%	±15%	±20%	±30%	100KHz/1V	0.70	0.66	0.75	0.70	850
SMDH8040NF-471□-Z01	470	±10%	±15%	±20%	±30%	100KHz/1V	0.63	0.58	0.60	0.55	1300

Note:

1. All test data referenced to 25°C ambient .
2. Testing Instrument : HP4284A,CH11025,CH3302,CH1320 ,CH1320S LCR METER / Rdc:CH502BC MICRO OHMMETER.
3. Heat Rated Current (I rms) will cause the coil temperature rise approximately t of 40°C .
4. Saturation Current (Isat) will cause L0 to drop approximately 30%.
5. The part temperature (ambient + temp rise) should not exceed 125°C under worst case operating conditions.Circuit design,component,PCB trace size and thickness,airflow and other cooling provisions all affect the part temperature. Part temperature should be verified in the end application.
6. Special inquiries besides the above common used types can be met on your requirement.

### 5. Typical Performance Curves

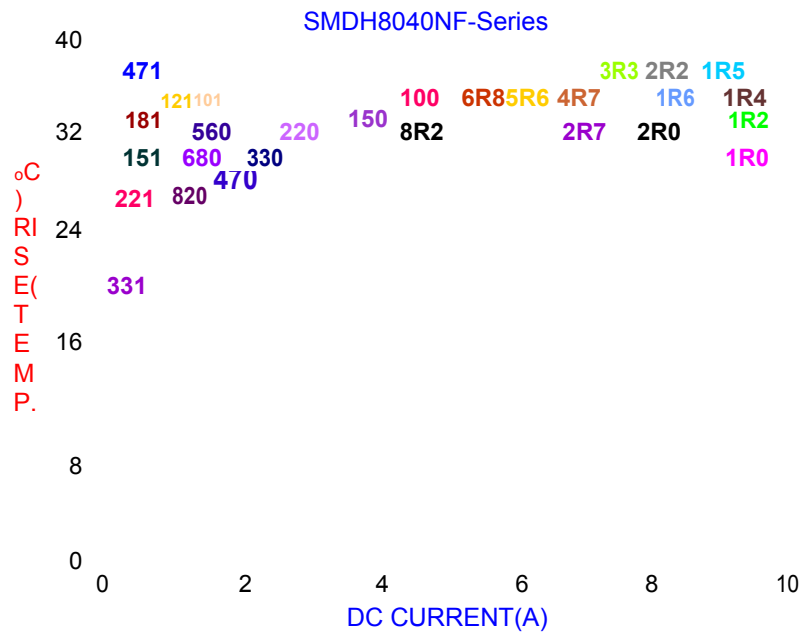

www.tocosc.com